



UK OVAL TRACK LEGENDS **2025 RULES**



| | | |
|----|--|----|
| 1. | Clarification Of Existing Rules..... | 2 |
| 2. | General Rules | 3 |
| 3. | Conduct | 12 |
| 4. | Technical Infringements..... | 13 |
| 5. | Technical Specifications – Safety Equipment..... | 15 |
| 6. | Technical Specifications – General..... | 17 |
| 7. | Technical Specifications – Engine..... | 34 |
| 8. | Technical Specifications – Appendices | 44 |

1. CLARIFICATION OF EXISTING RULES

The FZ09 fuel injection engine will not be permitted in the UK Oval Track Legends series.

You will be governed by the copy of these rules that are available and it is your responsibility to ensure that you read all the terms and conditions of the series and you are responsible for any rule infringements from when the UK Oval Track Legends rules are published on the web site:- www.spedeworth.co.uk

All drivers will receive a copy of the rules with their ORCI licence.

Should your wings become detached, either partially or fully, from a mounting point, you will receive a Technical Disqualification. Wing-Stays must be removed if you wish to race without your wings for the remainder of the meeting.

Wing-Stays must remain as stock items supplied by US Legend Cars in length, width and thickness for your particular model of Legend Car.

If you reach twenty Bad-Boy Points or more, you are not allowed to continue racing in that meeting. Your ban will start from the next meeting.

DRIVERS FUND

The UK Oval Track Legend Series supports a self-administered fund.

Each driver competing in the series should pay their contribution to the fund annually before the season commences.

The OTL Rule book is governed by the Oval Racing Council in the UK

2. GENERAL RULES

BOOKING IN TO RACE

Drivers are requested to book in by Tuesday of the week of the meeting, if possible. This assists in website advertising for that meeting. We will accept bookings up until Thursday 4pm prior to the date of the meeting unless the event is a mid-week event e.g. Arlington Stadium (Wednesday) when bookings will close at 5pm on the day before. All driver bookings up to this point will be included in the formation of grids. Bookings can only be made by calling 01252 322920 and the race fee of £25.00 per booking is required at time of booking.

Drivers booking after this time will be required to start all races at the rear of the main grid for the meeting except in Championship events using reverse grids where points dictate your starting position in the final – you will still be required however to start the qualifying heats from the rear of the grid.

CANCELLATIONS

Having booked to race, you are required to officially cancel your booking if you are unable to honour it. The only options for this are : Leave a message on the booking line, send a cancellation email to the booking line, or under exceptional circumstances you may text, Paul Fiore 07785 275 157 or Peggyann Lilley 07759 715 876.

Drivers that arrive at a race meeting and refuse to race (unless due to a proven mechanical issue), will be treated as a non-cancellation of booking.

Drivers who fail to cancel will be fined £30, payable prior to the next meeting.

POINTS SYSTEM

All races score points as follows-

1st - 200, 2nd – 175, 3rd – 155, 4th – 140, 5th – 130, 6th – 120, 7th – 110, 8th – 100, 9th – 90, 10th – 80, 11th – 70, 12th – 60, 13th – 50, 14th – 40, 15th – 30.

20 points for all other finishers

10 points for all other starters but non-finishers

0 points for non-starters or disqualified driver

GRADING

The grading will be based on Race Average which will be calculated after each meeting.

The Race Average is based upon the average per meeting on a 600 points basis (2 heats + Final). If a meeting allows a different maximum number of points possible, then the average for that meeting will be adjusted accordingly.

For the first three meetings of a season for each driver, the average is restricted not to drop below 75% of the driver's average at the end of the previous season and not to increase more than 150% of the driver's average at the end of the previous season.

After a driver has competed in three meetings then the average will be calculated based on the number of meetings raced and not restricted. 'Demonstration' designated meetings will not be part of the race average calculation.

Drivers will be graded as follows; however, the grader is given the authority to amend the number of drivers in each grade, Red and below.

| | |
|--------------|--|
| RED | Top eight drivers |
| BLUE | Next eight drivers |
| YELLOW | Next eight drivers |
| WHITE | All remaining drivers that are not Rookie status |
| PROBATIONARY | (See Disciplinary) |
| ROOKIE | New drivers to Legends deemed by the Race Director as a Rookie |

Grades will be subject to averages.

A driver that has not competed for three meetings will become an 'Inactive Driver' and will be removed from the published grading list. The driver will retain his honorary grade for future use.

~~Returning drivers will return at the current grade based on their previous grade.~~

ROOF COLOURS/GRADING STRIPES

Championship holders are required to paint their roof as follows :

| | | |
|-------------------|---|---|
| Points Champion | - | WHOLE ROOF SILVER |
| British Champion | - | WHOLE ROOF BLACK & WHITE CHEQUERED |
| National Champion | - | GOLD STRIPE DOWN THE LENGTH OF THE ROOF |
| European Champion | - | WHOLE ROOF RED & YELLOW CHEQUERED |

All above champions retain red grade status.

No other roof colour that may resemble any other Championship from any formula is allowed e.g. Gold, Union Flag etc. If you achieve red grade status you will not be permitted to drop below a yellow grade thereafter.

Flashing roof lights are only allowed for the four major championships. Points, National, European, and British champion.

Championship sign writing is allowed on the roof for the year of the reign only. No other Championship sign writing is allowed.

The top 1200 points scorer for the season will receive a trophy for their efforts however this is NOT A CHAMPIONSHIP and will not be referred to as such.

CHAMPIONSHIPS

There are three Official Championships as follows:

- NATIONAL
- BRITISH
- EUROPEAN

Qualifiers will be taken from the current points chart OR at the Promoters discretion based on the number of cars required.

The grids for the above meetings will be drawn "from the hat" with reverse grids. The Championship race will be started in points order gained from the heats, highest at the front of the grid. In the event of a tie-on points the fastest lap time taken from the two heats will be used per driver to determine starting grid positions.

Guest and Rookie drivers will start at the rear of the grid for the heats but may join the grid based on the heat qualifying points for the Championship final.

The minimum age for a UK Oval Track Legend driver is sixteen years old (with parental consent for those under 18).

For Masters Division your age will be taken from the start date of your ORCi licence.

Points for these divisions will be taken from the NATIONAL POINTS CHART in order to determine the winners each year.

ROOKIE DRIVERS

New drivers will be allocated Rookie Status and will start from the rear of the field for their first three point scoring meetings. The only exception to this will be drivers who have held an ORCi licence for a non-contact formula (except Rookie Rods), who will be considered to be allowed to start from a grade.

Following two meetings as a Rookie, the Race Director/Steward of the Meeting will decide if driving standards have reached an acceptable level for a driver to move forward into a graded position. In addition to the driving standards over those first three meetings, the number of racing laps completed will also be taken into consideration. For example, if a driver has competed three times, but literally only completed a handful of laps, then the driver may well not be granted the right to move forward into the normal grading system. In such cases, the driver will termed 'Probationary' and will grid behind the normal graded drivers, but ahead of any Novice drivers. The driver will remain on probation until such time that the Race Director considers the driver has displayed an acceptable level of driving standards. During this period, the black cross should remain on the rear of the car.

PROBATIONARY DRIVERS

In addition to Rookie drivers becoming Probationary drivers before graduating into the full grading system, drivers who display considerable concern with their driving standards may be placed on 'Probation' for a period of time. The driver will remain on probation until such time that the Race Director considers the driver has displayed an acceptable level of driving standards.

STARTS

Format for starts is as follows

- There will be one rolling lap
- Rolling lap to be dictated by Pace Car
- All cars to start off at the same time when rolling lap commences

- Cars are not allowed to accelerate/decelerate whilst on rolling lap
- The front inside car of each grade should maintain the gap from the grade ahead
- There must be NO ACCELERATION until the green flag drops at which point the cars should "burst into life".

Starts will be further controlled by instruction from the Racever

Any car deemed to have "jumped the start" may be disqualified or docked positions by the Steward of the Meeting.

If, in the opinion of the Steward of the Meeting a driver is out of position on the rolling lap then he may be disqualified and there can be no appeal.

RACE FORMAT

Heats to be lined up reversed grid within grades. Heat 1 based on the last event points chart with the lowest grade average driver on pole per grade. ~~as per current points chart.~~

Final to be lined up in points order within grades. Grids are constructed using points gained from heats via the Oval Track Legends points system, in the event of a tie-on points the fastest lap time taken from the heats will be used per driver to determine starting grid positions.

The following race caution procedure will take affect at certain promotions during 2025:- On the re-start following a race stoppage a double file line-up will be created on the restart rolling lap(s) within a certain area of the track which will be declared at the drivers briefing. Within the designated area drivers have the choice to start either on the inside or outside line. A driver cannot be in the middle of the track or change lines once you have committed to a line. If a driver has failed to commit to a line (Steward of the Meetings discretion is final) before leaving the designated area will forfeit their position on the restart and be sent to the rear of the grid prior to the re-start green flag being waved.

Race winners will start at the rear of their grade for the remainder of the meeting. If a driver wins both his heats he will be automatically upgraded to the front of the next grade for the final.

For any non-starters the grid positions will be left vacant.

Drivers cannot swap programmed heats under any circumstances. Drivers must compete in their allocated heats irrespective of situation as per the published grids.

RACE STOPPAGES

If you are deemed to be the primary cause of the stoppage of a race, you will be excluded from any possible re-start, but this will not attract Bad Boy Points.

RED FLAG

When a Red Flag is instigated drivers are required to stop as quickly as possible AND MUST NOT OVERTAKE ANY OTHER CARS, but in a safe manner. We would expect this to be within ¼ of a lap.

Drivers must remain stationary until such time that they are instructed to do otherwise. Please be aware that individual drivers may be asked to move, to assist access to an incident, however this does not mean that all cars can then move. You should listen for instruction from your Raceivers and direct instruction from a race marshal.

Following a red flag incident the re-start of the race will be THE SAME AS A YELLOW FLAG RE-START.

All drivers that overtake under a red flag will automatically be EXCLUDED from the race.

In all cases the Steward of the Meeting's decision will be FINAL.

YELLOW FLAG CAUTIONS

All cars to single file themselves; there must be NO OVERTAKING WHATSOEVER. This is irrespective of your race position. Lapped cars are not allowed to un-lap themselves, just stay in position, otherwise you will be excluded. On instruction of the Steward of the Meeting prior to a race restart any back markers who are positioned within the first six places will be permitted to un-lap themselves and go to the rear of the grid. The lead car should follow the Pace Car, but under no circumstances overtake it. Drivers that do overtake the Pace Car will be immediately excluded from the race.

Drivers should also raise a hand out of the window to further enhance that the yellow flag has been instigated.

Cars must keep behind the Pace Car (unless instructed otherwise) and must keep single file without gaps, until the race restart.

Unless directed, all drivers that overtake under a yellow flag will automatically be EXCLUDED from the rest of the race.

If a driver exits his car under a yellow flag he will automatically be EXCLUDED from the rest of the race. Cars that are caught up in an incident that are NOT deemed to be the primary cause of the stoppage will be allowed re-join at the rear of the field provided they have not received outside assistance.

BLACK FLAG / TECHNICAL DISQUALIFICATION FLAG (White flag w/ red cross)

If you receive either a black flag or technical disqualification flag you must retire to the infield at the earliest opportunity when it is safe to do so. Failure to retire from the race will result in disciplinary action.

BLUE FLAGS

If a driver receives two consecutive blue flags and continues to ignore this warning he will receive Blue and White striped flag which instructs the driver to give up his position; failure to obey this flag will attract a BLACK FLAG and an automatic disqualification from the race.

CHEQUERED FLAG

Drivers must continue to keep at racing speed after the chequered flag, until the red flag is shown.

TECH INSPECTION

An official appointed Tech Inspector can ask any driver to make his car available for inspection at any time during the course of a meeting. At the time the tech inspector is checking a car the DRIVER AND ONE MECHANIC only should be present.

The driver or an appointed team member is responsible for removing any item that the Tech inspector wishes to check – the Tech inspector does not remove these items. If an item to be checked cannot or will not be removed when requested that car will be deemed to be illegal.

Drivers are reminded that the tech inspector is an appointed official and must be treated with respect. Failure to do so will be treated at the Race Directors discretion and may incur a penalty.

PRE-MEETING DRIVERS BRIEFING

It is compulsory that a driver personally attends the pre-meeting drivers briefing and does not send a representative except with prior permission of the Steward.

SWAPPING CARS

A driver cannot swap cars – the rule is one car, one driver per meeting which means that a driver cannot swap cars at the point that a car has been used in a meeting. The point of use is the point that the car is driven onto the raceway for OFFICIAL pre-meeting practice or racing.

RADIO TRANSMITTERS & RECEIVERS

All drivers MUST use an official Receiver.

Any driver whose Receiver is not working when forming the grid prior to a race will not be allowed to race, unless it can be repaired before the race start.

We advise that you carry a spare battery either in your overall pocket or taped inside your car.

It is against the Rules to use any other radio transmitters than the official Receivers as this contravenes 600 RACING Rule 57 and an automatic driver ban will be issued immediately and reported of OFCOM – the U.K. licensing body.

TRANSPONDERS

A timing transponder must be mounted on the outside of the rear chassis down bar (2"x1") adjacent to the rear wheel. The transponder must have a direct line of sight to the track. The distance will be checked randomly and you will risk exclusion if your transponder is fitted further forward than the required distance. Transponders must be securely fitted and must have a permanent feed (if hard wired) only being disabled by the master isolator. You will be informed after practice (if available) if your module is not functioning, but following that if your transponder is still not working then you will not be lap scored electronically and manual lap scoring results cannot be disputed.

TYRES

It is prohibited to use traction compounds or any substance that might alter the physical properties of a tyre as supplied by the manufacturer. Tyre cleaners, shiners, softeners,

track adhesives, brake fluid, diesel fuel etc. will not be permitted on the tyre. Any tyres with signs of these products on them will be DESTROYED IMMEDIATELY and that driver will be disqualified immediately and a twelve month ban will be implemented.

The most significant test for this will be with the durometer and any tyre found to be below the rule book minimum of 58 points will be deemed to have been softened and will be destroyed.

At a race event, tyre buffing is allowed only by the use of a manual surform and the wheel/tyre must be still, i.e. not mechanically turning. The buffing of tyres in the pits on an electric motor or running on a car is strictly forbidden.

MANDATORY RACE PROCEDURE CONCERNING BUMPERS

The Rule Book states "if a bumper comes completely off the car or has any part of it touching the ground, or is in a dangerous position, that car may be excluded (with a white flag/red cross technical disqualification flag) by the track officials and removed from the race. The Technical Inspector does not have the authority to disqualify a driver after the race for violation of the race procedure."

The word "may" in the rules regarding being black flagged means SHOULD in English – this is a typical American way of writing the rules.

If the Steward does not see the trailing bumper and the driver is not black flagged, then the rule does state that post race exclusion is not allowed.

LIFTING EYES

Lifting eyes must be fitted to the front and rear chassis legs on all four corners. They can be on the inside or the outside of the rail. If bolted with one nut and bolt a spacer (2mm thick and 10mm in diameter) may be inserted in the chassis rail.

CAR PURCHASING

New cars can only be supplied by Derek Hales Ltd as the official European Racing Dealer for UK Oval Track Legends.

It is prohibited to import from America or to purchase from the Long Track Dealer a new or second hand car and transfer it to a short Oval.

In terms of second hand cars, from 1st July 2004 it was implemented that only Short Track second hand cars can be purchased, you cannot purchase a car from the Long Circuits. There is one exception to this where a current Long Track Legend driver wishes to transfer and race on Short Ovals with his current long track car which must comply with the current specification as stated in this rule book and must compete for at least five meetings before it can be sold to the Ovals. In this instance the driver must apply to the Promoter who will consider his application for transfer of the chassis. (This is to help protect the investment you have made in your car).

NB- All new car parts including engines as manufactured and supplied by 600 Racing must be purchased from the official UK Oval Track legend dealer.

UPON ENTERING A LEGEND CAR for competition any car may be checked for engine chassis oil, fuel, tyres, wheels, rear ends, or sound legality at any time by an official or representative.

Upon entering a legend car for all events sanctioned competition, the driver is responsible for the legality of their car and will suffer all penalties resulting with the Legend Car violating these rules.

Refusal to submit a car, engine or parts for inspection or measurement upon the request if a tech Inspector or representative will result in an immediate disqualification and may lead to suspension or any other penalty issued by the Steward of the Meeting for the car and driver.

IF THIS RULE BOOK DOES NOT SPECIFICALLY SAY THAT YOU CAN CHANGE/MODIFY/ADD SOMETHING THEN YOU MUST CONSIDER THAT ANY SUCH CHANGE/MODIFY/ADDITION IS ILLEGAL.

NO EQUIPMENT OR RACE CAR WILL BE CONSIDERED AS HAVING BEEN APPROVED BY REASON OF HAVING PASSED THROUGH AN INSPECTION 'UNOBSERVED'. Regardless a Legend Car passing prior inspections, compliance with all rules must be made at each post-race inspection. No expressed or implied warranty of safety shall result from the technical inspection or approval enforcement of specification rules. All 600 RACING approved weighing measuring and testing devices used by the technical officials are the standards which will determine the compliance with the rules and regulations. The competitor's equipment gage or instrument unless approved by the inspectors will have no bearing on the enforcement of these rules. The car must start in tech area to perform inspections that require the car to start.

DRIVING STANDARDS

There seems to be some doubt about the non-contact rules in Legends. It must be emphasised therefore that NON CONTACT MEANS NON CONTACT.

Intentional front to back bumper contact is not permitted. Stewards will watch out for offenders who will be punished either by being docked places, excluded or even loaded up.

"Rough Driving" – If anyone is observed causing other drivers to spin or lose control of their car, that driver will be warned, penalised or disqualified at the officials' discretion depending on severity. Please respect other competitors' equipment.

"Passing" – It is the responsibility of both the overtaking and overtaken driver to assure safe passing at racing speeds. A driver being overtaken must give the overtaking driver a lane to race. A driver travelling alone may use the full width of the track but once he/she is challenged, they must select a lane to race in. Passing may be either right or left depending on the conditions of the moment (not through that car), except on initial starts. Cars that are being lapped should do their best to allow the lapping cars to overtake i.e. they should choose a racing lane, either outside or inside and stick to it, until the lapping cars have passed.

Where there are two cars racing side by side being lapped, the car on the outside MUST give up his position and drop back behind the inside car, thus allowing the lapping cars to overtake.

CONTACT

Avoidable contact will result in a black cross, black flag or disqualification following a stewards investigation. A driver receiving the black flag must leave the track at the earliest, safest opportunity. Any driver who ignores the BLACK flag will be EXCLUDED from the meeting without appeal; with the Raceiver information and flag system there can be no question that you have been black flagged – it is not permissible to appeal the black flag by continuing racing and talking about it afterwards.

A standard ten meeting ban for retaliation will be applied, part of which may be suspended for a period of 12 months.

DISCIPLINARY POINTS

Driving standards must conform to the rules as noted above; failure to do so will result in 5 or 10 'Bad Boy' points depending upon the severity of the infringement

Disciplinary points are awarded as follows:

- 5 points for a race disqualification
- 10 points for a "load up".

If a driver reaches 20 disciplinary points in a rolling period of 12 months, then an automatic ban of 2 meetings is instigated; attaining thirty points within twelve months will attract a further three meeting ban. NOTE A twelve month period is a full twelve months and does NOT re-commence with zero at the start of each season

AT ALL TIMES THE DECISION OF THE STEWARD REMAINS FINAL

3. CONDUCT

THREATENING BEHAVIOUR

Threatening and abusive behaviour will not be tolerated by either a driver or his team members. The driver is responsible for the behaviour of his team members at all times. Both the Steward and the Promoter have a duty of care and threats to other drivers and/or teams will result in exclusion or possibly a ban.

STANDARD ORCI BANS

Refusing to surrender parts to the Tech inspectors request will result in a 12 month ORCi Ban

- Verbal Abuse carries a standard 3 month ORCi Ban
- Threatening Behaviour carries an automatic 6 month ORCi Ban
- Physical Violence carries an automatic 12 month ORCi Ban for the first offence
- A second Physical Violence carries an automatic 3 year ORCi Ban
- A third Physical Violence means a life ban.

Any of the above offences towards an Official carries ***double*** the above penalties.

Character Assassination on any Social Media site will be dealt with under the Verbal abuse or Threatening Behaviour headings as above dependent upon context of the script. Please note that drivers, you will be held responsible for all of your family and any associated team members.

4. TECHNICAL INFRINGEMENTS

Any part not supplied or approved by 600 RACING (US Legend Cars International) and any part that had been altered in any way will attract the standard ORCi ban, ranging from six to twelve months depending on the severity of the infringement. The part will be confiscated by the promoter and returned to US Legend Cars or destroyed on their instruction.

All parts must be purchased through the UK Legend dealer:

The Promotion and Tech Inspectors reserve the right to confiscate any part including engines in order to obtain an independent report to ensure they comply with the rules stated in this rule book. Failure to comply with this rule is a standard ORCi 12 month ban,

Any licenced driver that is racing on the day may put up a £500 bond and request any 1250cc engine to be checked by an independent adjudicator appointed by the Promotion. If the engine is found to be legal, the money will be awarded to the protested driver, conversely if the engine is found to be illegal, the money will be returned to the protestor. Again, failure to comply with the request for the engine to be stripped will result in an automatic 12 month ORCi ban.

PENALTIES

Engine including cranking compression, Gearbox, (any internal measurement that does not correspond with the standard measurement as stated by the manufacturer or US legend cars) Diff, Shock Absorber, Engine Seals (Any Alteration or deviation to the original component that does not comply to the standard supplied by US legend cars)

- ✓ First offence – six month ban.
- ✓ Second offence – twelve month ban.

Suspension, half shafts, body panels, any part that has been modified, lightened or that does not meet the INDIVIDUAL weight limits of PARTS as stated in this Rule Book.

- ✓ First offence – two - six meeting ban.
- ✓ Second offence – six - ten meeting ban.
- ✓ Third offence – ten - sixteen meeting ban.

Note – Meeting bans **will** be carried forward to the following season where necessary. All Oval Track Legends bans will also extend to all INEX sanctioned meetings irrespective of whether they are held on the Ovals or Circuits.

Measured Infringements

Any EXTERNAL measurement including VEHICLE weights that do not comply as stated in this rule book will attract the following disciplinary actions : EXAMPLES : Ride Heights Wheel Base Track Width Axle Offset Alternator/Charging System and any other external part not already stated.

- ✓ First offence – Disqualified from race
- ✓ Second offence – Disqualified from the meeting losing all points.
- ✓ Third Offence – Three meeting full ORCi ban.

Each offence is calculated on a 12 month rolling period. Offences already registered since 1st January 2022 will be carried into the new format. i.e. If you have a technical disqualification issued on the 3rd May 2022 it will remain active until 4th May 2023. A further offence within this time period will result in the next tier offence being activated.

5. TECHNICAL SPECIFICATIONS - SAFETY EQUIPMENT

NO EXPRESS OR IMPLIED WARRANTY OF SAFETY SHALL RESULT FROM PUBLICATION OF OR COMPLIANCE WITH THESE RULES AND REGULATIONS. THEY ARE INTENDED AS A GUIDE FOR THE CONDUCT OF THE SPORT IN NO WAY A GUARANTEE AGAINST INJURY OR DEATH OF PARTICIPANTS SUPPORTERS OR OTHERS. WHENEVER THERE IS A CONFLICT BETWEEN A SAFETY PROVISION HEREIN AND ANY OTHER RULE THE SAFETY PROVISION SHALL TAKE PRECEDENCE.

Helmets

As per the ORCi website (www.orci.co.uk) for current regulations. If wearing an open face helmet shatterproof goggles must be worn.

Gloves

As per the ORCi website (www.orci.co.uk) for current regulations.

Race Suits

As per the ORCi website (www.orci.co.uk) for current regulations.

Balaclavas

As per the ORCi website (www.orci.co.uk) for current regulations.

Raceievers

Must be in working order at all times. (It is advised you carry a spare battery with you)

Neck and Head Restraints

As per the ORCi website (www.orci.co.uk) for current regulations. In Oval Track Legends forward facing head restraints are optional. e.g. Hans device.

Safety Harness

As per the ORCi website (www.orci.co.uk) for current regulations.

Roll bar padding

Roll bar padding SFI-45.1 on all exposed bars within one foot of the driver's helmet is MANDATORY.

Fire Extinguishers

As per the ORCi website (www.orci.co.uk) for current regulations.

A 2KG fire extinguisher is MANDATORY and must be visible and secured in your transporter or trailer. This extinguisher must be either Powder or Foam and NOT Water.

Electrical

A battery key type cut-off switch is mandatory and must cut all power – it must be fitted to the left rear shelf inside the cab and clearly signed on the outside with an ORCi Cut-Off Switch sticker.

Seats

Only competition approved manufactured seats may be used. No homemade seats will be permitted. Lightening the seat by anyone other than the factory is not permitted.

Mounting the seat in the legend car - The seat may be moved within the drivers compartment without moving or changing existing bars in the frame. The centre line of the seat must be a minimum of TEN INCHES from the left side of the driver's compartment roll cage. The seat may be mounted directly to the floor pan. When mounting the seat forward, it must have a rear support. All supports and mountings must be of metal.

ALL OF THE ABOVE SAFETY EQUIPMENT IS MANDATORY AND MUST BE ORCi APPROVED.

THE TECH INSPECTORS / SCRUTINEERS HAVE THE FINAL SAY ON ALL SAFETY EQUIPMENT AND ITS COMPLIANCE.

If in any doubt about the above rules please visit the ORCi website:-
www.orci.co.uk

6. TECHNICAL SPECIFICATIONS : GENERAL

The registered driver takes full responsibility to ensure that their race car conforms to all the rules as stated in this rule book.

Technical Inspections

The main items that could be checked at championships and random domestic meetings are as follows:-

1. Wheel Base & Ride Heights
2. Track Width
3. Axle Offset
4. Axle Brackets
5. Chassis Pick Up Points
6. Brake Disc Thickness
7. Brake Drum Weights
8. Car Weights
9. Alternator Charging
10. Carburettor Intake Diameter
11. Cam Lift / Cam Bolts
12. Engine Cranking Compression

There is a wide range of further technical checks available to the technical inspectors at their discretion or as stated within this rule book.

At major championships you will be required to draw three numbers from the hat. Should the necessary technical inspection tools be unavailable on the day the draw number relating to the relevant check will be removed prior to the draw. ***This will be at the Stewards discretion at the event.***

PLEASE ENSURE THAT YOU FULLY UNDERSTAND THE RULES AND DISCIPLINARY PROCEDURES FOR FAILURE IN COMPLIANCE.

FRAMES, BODY, SUSPENSION, etc.:

1. **AERODYNAMICS** : Spoilers, air dams or other aerodynamic devices are not permitted.
2. **AIR FILTERS** : Only stock and K & N air filters and Outerwear's Pre-Filters coverings as delivered by US Legend Cars are permitted. Velocity/ram stacks are not permitted. No components that direct airflow to the carburettors or increase airflow are permitted.
3. **ALTERNATORS** : Modification to the charging system is not permitted. The alternator must be charging at all times. No switches disconnecting the alternator are permitted. The engine must continue to run at an idle with the battery disconnected (EIRI).

4. **BALL JOINTS** : The upper and lower ball joints must remain stock, within the stock dimensions, steel thickness, location and configurations as delivered new by U.S. Legend Cars International and may not be reinforced in any way. One or two (minimum 1/4", maximum 7/16" width) jam nuts are permitted on the upper and lower ball joints. Each ball joint must use at least one jam nut. The jam nuts may not be welded to the control arms. Anything limiting the natural travel of the stock ball joint as delivered by U.S. Legend Cars International is not permitted.
5. **BALLAST** : Ballast must be bolted with 3/8 or 10mm bolts to the main chassis rails on the inside or the outside of the main rail and must not hang below the rail. No ballast is allowed in the cockpit. Ballast must be in blocks of 12 inches in length, 1 1/2 inches in width and 2 1/2 inches in depth.
6. **BATTERY** : Only a lead acid or gel cell battery (25lbs. min.) may be used. A top post or side post battery may be used. Motorcycle batteries may not be used. The battery must remain in its stock location and securely mounted. The original stock battery bracket may not be altered in any way. Starter solenoid must remain mounted on the battery bracket. A battery box, terminal coverings or rubber padding around rear end is also highly recommended. A battery cut-off switch is mandatory and must cut all power – it must be fitted to the left rear shelf inside the cab and clearly signed on the outside with an ORCi Cut-Off Switch sticker.
REF:- Diagram 01
7. **BOLTS AND FASTENERS** : All suspension and steering nuts and bolts must be of a magnetic type and no modifications for lightening (Tech Inspectors discretion). In addition **BODY PANELS** : May use alloy plastic or steel fixings – again Tech Inspectors discretion
8. **BRAKES** : Any of the brake parts that are attached to the rear end or the spindles must remain stock, within the stock dimensions, steel thickness, location and configurations as delivered new by U.S. Legend Cars International. The car must have operational brakes on all four wheels and must lock up all four wheels during inspections (Brake lines may not be plugged or completely shut off). Any type of cooling duct to the brakes is prohibited. The right or left side brake pedal may be removed. Brake Rotors -Only steel rotors (not drilled or reduced in diameter) are permitted on the front. The minimum permitted thickness of the brake rotor is 8mm. Brake Drums -Only steel drums (not drilled or lightened) are permitted on the rear. The minimum weight of the brake drum is 10.0 lb. Intentional metal removal of the brake drum for lightening purposes or "offset" is considered illegal. Only the "shoe face" may be machined. Brake & Clutch Lines -Rubber, hard-line or steel-braided brake and clutch lines are permitted. No brake lines may be disconnected or plugged at any time for competition. Brake Master Cylinder -The brake master cylinder must remain stock, within the stock dimensions, location and configurations as delivered by U.S. Legend Cars International. The brake master cylinder must remain on the engine side of the firewall. No aftermarket brake master cylinders are permitted. Aftermarket remote reservoirs are permitted. Brake Proportion valves -Only one brake valve, residual valve, pressure valve will be allowed; One unit per complete brake system. Complete elimination of the brake at any wheel is prohibited.

- a. **BRAKE LIGHTS** A fluid operated rear brake light (Mini brake light switch fitted directly to the brake master cylinder) must be fitted to the rear of the car just below the rear window aperture. LED strip lights are permitted. REF:- Diagram 02
9. **BUMP STEER** : Adjustments to bump steer settings will only be permitted by placing spacers between the steering rack and the heim ends of the tie rods or between the front spindle pickup points and the heim ends of the tie rods. No other modifications to adjust bump steer such as changing the height of the steering rack or modifying the spindles are permitted.
10. **BUMPERS** : Front Bumper -The front bumper must remain within the stock dimensions, steel thickness, location and configurations as delivered new by U.S. Legend Cars International and may not be reinforced in any way, except for adding one (1) additional bolt per front and/or rear frame rail to the tab. Rear Bumper - The rear bumper must remain within the stock dimensions, steel thickness, location and configurations as delivered new by U.S. Legend Cars International. The rear bumper may be reinforced by attaching tubular steel from the bumper to the rear frame horns. Adding one (1) additional bolt per frame rail to the tab is permitted. If reinforced, the steel tubing may not extend beyond the outside width of the rear wings or attach to the rear cross member of the frame and may be no longer than twelve (12") inches. Attachment of the Bumper – Bumper tabs must use a minimum of one bolt per tab securing the bumper. There must be a minimum of 1" from the end of the frame rail to the back of the bumper upright before a race begins. Should the tab become bent during a race, it must be fixed before the next time the car goes on the track to compete or practice. Tie-wraps, safety wire, duct tape, etc., are not permitted to secure the front or rear bumpers or bumper tabs at any time. Bumper Tabs -The bumper tabs must be stock as delivered by U.S. Legend Cars International and may not exceed 1/8" (.125") in thickness. Tabs stamped "INEX" as delivered by U.S. Legend Cars International will be .140" thick. Tabs with excessive weld may be considered illegal. Repairing a bumper During a Race: Bumpers must be bolted on. Tie-wraps, safety wire, duct tape, etc., are not permitted to repair the front or rear bumpers at any time. An 600 RACING technical inspector will disqualify a driver after a race if the repaired bumper violates this rule. Mandatory race Procedure concerning Bumpers If a bumper comes completely off the car or has any part of it touching the ground, or is in a dangerous position, that car may be black flagged by the track officials and removed from the race. The 600 RACING technical inspector does not have the authority to disqualify a driver after the race for a violation of this race procedure. REF:- Diagram 03
11. **CARBON FIBRE** : Carbon fibre is not permitted to be used on any Legend Car.
12. **CARBURETORS** : The carburetors and components of the carburetors must remain as stock Yamaha FJ1200/ XJ1200/XJ1250 (sealed) as delivered new by U.S. Legend Cars International. Only carburetor jets, needles, slide springs and butterfly screws (butterfly screws may only be replaced with 3m. X 6m. Allen head screws or stock screws. These screws may not be altered in any way other than "stamping" the end to secure the screw) may be replaced and all stock adjusters may be used. No other modifications to the carburetors or components of the carburetors are permitted. 45 Modifications or components to increase or restrict airflow or fuel

flow (such as velocity stacks, heat deflector shields, internal modifications not listed above, etc.) are not permitted. Throttle pedal stops are allowed as stated in the 600 RACING technical bulletin, dated April 2014.

13. **CHROME PLATING/POLISHING** : External parts such as bumpers, nerf bars, suspension components and cam cover may be chrome plated or polished.
14. **CLUTCH MASTER CYLINDER** : The clutch master cylinder must remain stock, within the stock dimensions, location and configurations as delivered new by U.S. Legend Cars International. The clutch master cylinder and reservoir must remain on the engine side of the firewall. No aftermarket clutch master cylinders are permitted. The clutch pedal may be shortened for driver comfort.
15. **CONTINGENCY SPONSOR DECALS** : Contingency sponsor decals are optional, however contingency decals are mandatory and /or use of the product to be eligible for posted awards sponsored by the contingency sponsor.
16. **DOOR PLATES** : Doorplates on driver's side door are mandatory. Doorplates and strike plates must meet current factory specifications. These door plates are permitted to be added to the right side door. A competitor may use a doorplate covering the entire door area on either side of the car (maximum of 1/8" thick).
17. **DRIVESHAFT/PROP SHAFT** : The driveshaft, flanges, and u-joints and all components of the driveshaft must remain within the stock dimensions, steel thickness, location, weight (14lbs. minimum) and configurations as delivered new by U.S. Legend Cars International. Lightening the driveshaft in any way is illegal. Driveshaft must be painted white or light grey. Driveshaft retainers - 600 RACING-approved driveshaft retainer strap is permitted. A maximum of three (3) retainers of 1/4" thickness and 3/4" width are permitted. Requests for additional retainers for the driveshaft must be sent to and approved in writing by 600 RACING. Legend Cars are permitted to use longer shifter handles. These handles must be 15" or shorter from the top of the driveshaft tunnel to the top of the shifter handle. These 'longer' shifter handles will be available through US Legend Cars International.
18. **ENGINE COATINGS** : Only coatings as delivered stock from the factory are permitted throughout the engine. Intentional removal of any coatings is not permitted. Headers may be painted with high heat paint only. (Header wrap tape is ok.) Repainting the outside of the engine or using an unpainted engine is permitted.
19. **ENGINE COOLING** : Extra fans, internal duct work, bonnet louvers, remote oil filter, header wrap, holes in the bonnet, holes in the front wings and/or oil coolers are permitted. The maximum height for louvers is 3/8". The size of the area for louvers or holes in the bonnet may not exceed 54 square inches (9" x 6"). These components may not direct air to the carburetors or air filters in any way. **NO WATER COOLED ENGINES ALLOWED.**
20. **ENGINE SERIAL NUMBERS** : All engine casings must have a serial number. Any engine casing without a serial number will not be permitted to be used in any 600 RACING-sanctioned events.

21. **ENGINE LOCATION & MOUNTS** : Left and right side engine mounts must remain within the stock dimensions, steel thickness (no aluminium mounts), location and configurations as delivered new by U.S. Legend Cars International. The right side motor mount may be replaced with the optional motor mount as delivered by U.S. Legend Cars International (if the optional right side mount is used, you may remove the stock right side mounting tabs). Rubber mounts will be permitted as long as the engine remains in the stock location. The engine mounts must be bolted on to the frame as specified by U.S. Legend Cars International. Mounts may not be welded directly to the frame. REF:- Diagram 04
22. **EXHAUST SYSTEM** : The header, collector and gasket must remain within the stock dimensions, steel thickness, location and configurations of the original, as delivered new by U.S. Legend Cars International. The internal components of the header and muffler may not be altered. The centre section of the ~~Simpson~~ exhaust box must be a continuous bore size. The ends can be swaged out for fitment purposes only. The tail pipe must not be height than the top edge of the rear bumper. Stock U.S. Legend Cars International, Borla and S&S exhaust systems (approved by 600 RACING and delivered by U.S. Legend Cars International, Inc.) are mandatory. Header wrapping (tape) is acceptable. Ceramic coatings are not permitted. Ceramic / Baked-on coatings are not permitted on the exhaust pipes or mufflers. Silencers and exhaust manifolds must be supplied by the Oval Track Legends dealer.
23. **WING MOUNTING** : Stock wing mounts may not be altered. No additional wing supports or mounts are permitted (only stock mounts may be used). All '37 Ford style grills must use the inner mounting hole (closest to the grill). DZUS buttons may be used for wing removal purposes only. Cars that use a fiberglass grill shell may remove the original wing brackets. Area under the Rear Wings -Removal of the fiberglass on the body half under the rear wings is permitted for easier access to the shocks, springs and rear compartment as long as it is still in the spirit of the General Appearance Rule (Page 49, Rule #38).
24. **WING HOLES and TRIMMING** : The trimming and holes that are permitted are as follows: Holes -Ten (10) round holes maximum per WING. These holes may not be any larger than four (4) inches in diameter maximum (Note: a four inch hole saw will produce a hole larger than four inches). Any shaped hole equal to or less than the area of a 4" round hole is acceptable. Trimming -The only trimming allowed on the inside edge of the wing will be for engine clearance (air breathers, header, etc.) this trimming must be done 12" above the frame rail on the front clip along the contour of the wing, and may only be trimmed in 3" from the edge. The inside of the wings near the grille, the edge of the wings near the body shell, and the bottom edge of the front of the wing may not be trimmed.
- a. **REAR WINGS** : Rear wings may be trimmed above the tyre for additional clearance. The rear wing contour must measure at least nine (9) inches from the main body shell. Measurements will be taken at the point on either rear wing above top dead centre of the tire. No holes are permitted in the rear wings or body shell.

25. **FIBERGLASS COMPONENTS :**

- a. All fibreglass components must remain within the stock dimensions, thickness, location and configuration delivered by US Legend Cars International. All fibreglass components must have an authentic 600 RACING certificate embedded into the underside of the fibreglass component evidencing that the fibreglass component is a certified US Legend Cars International part delivered by US Legend Cars International dealer network.
- b. Additional numbered security stickers will be fitted to each car [internally to the bodies and externally to the wings for ease of inspection] these stickers must not be removed or sprayed over when repairs are undertaken.
- c. In the event that a fibreglass component is found without a security sticker then a new security certificate can be purchased from the Official Oval Track Legend dealer at a cost of £50.00 of which £32.00 will be forwarded to the Oval Track Legends Drivers Fund.
- d. Wing repairs and replacement must be authorised by the Tech Inspectors and noted in your ORCi Licence / Log Book.
- e. The stock length of the 1937 Chevy hood is 32" – 32 1/2" (measured down the middle) and may not be shortened.
- f. The fibreglass components may not be reinforced or intentionally lightened in any way. The use of a complete front end (matching bonnet, wings, grill and grill shell) on a different model is acceptable. It must be complete with all listed components from the same model. **Mounting components.** All fibreglass body components must be firmly attached to every Legends car competing in any race. It is recommended that all DZUS fasteners fit tight and are taped over to prevent loosening. Any Legends car may be black flagged or denied entry to start a race if any of the aforementioned items are not attached unless prior approval is given by the technical inspector. Removal of undamaged fibreglass components (boot, bonnet etc.) during a meeting is not permitted.

26. **FIREWALL :** A metal firewall is mandatory. Firewall must be installed as delivered new by U.S. Legend Cars International. Using a "thicker than stock" metal firewall separating the driver's compartment from the engine compartment is permitted.

27. **FRAME :** Absolutely no modifications of the frame (including roll cage) will be permitted unless otherwise noted in this rulebook. All frames must have I.D. plate secured on the frame. Frame Update -As of January 1, 2000, all Legend Cars frames (coupes and sedans) with an 0.065" E.R.W. main roll cage will no longer be eligible for competition in the 600 RACING Legend Cars Series. All frames must be replaced with a 0.083" D.O.M. main roll cage frame. It is estimated that all frames produced before August, 1995 do not meet the above 0.083" D.O.M. Requirements. Registration of a Legend Car -For more information about the titling, transferring ownership and registration of a Legend Car, please contact the titling department of U.S. Legend Cars International at (704) 455-3896. Serial number plates -All cars & frames running as Legend Cars must be produced by U.S. Legend Cars International. All cars must carry the serial number assigned to that frame. This plate shall not be tampered with in any way. For any reason, the car owner must also be able to produce the title for the car within 48 hours after a request by an 600 RACING technical official or that car will be ineligible for any competition. Metal Fatigue -It is highly recommended to have the frame checked periodically by an

expert for metal fatigue. Cracked or broken frames are strictly prohibited from any 600 RACING-sanctioned events. Suicide Doors -Doors with the latch on the A-Pillar and hinges on the B-Pillar rather than the traditional method of the latch on the B-Pillar and the hinges on the A-Pillar. Suicide doors are only permitted on the 1934 Ford and Chevy Coupe frame.

28. **FRAME REPLACEMENT** : If the chassis should become severely damaged, replacement frames must be purchased through U.S. Legend Cars International or its authorized dealer network.
29. **FRAME REPAIR** : Only front and rear clips may be replaced as long as they are replaced with the exact material that it is replacing and all pickup points must remain in the stock locations as delivered new from U.S. Legend Cars International. The clips may be purchased through U.S. Legend Cars International and its dealer network. The driver's compartment of the frame (roll bars, cross braces, etc.) may not be repaired or replaced if damaged. The technical inspector reserves the right to disallow a repaired car from a sanctioned competition that does not appear to be properly repaired. Once a frame is repaired from its original form, 600 RACING, U.S. Legend Cars International and the technical inspector assume no liability for any injuries that may occur as a result of this repair regardless of the approval given to compete with that repaired frame. REF:- Diagram 05
30. **FUEL** : Permitted fuel specification from 1st January 2008 (this specification supersedes all previous specs).
- a) All cars must only use fuel from roadside pumps as defined below.
 - i. Petrol (Motor Gasoline of the type on sale to the general public from roadside filling stations) BS 4040 (Leaded) Subject to a valid permit for use. LRG (Unleaded), BS EN 228 (Unleaded), BS7800 (Super Unleaded).
 - b) Petrol is a product refined from crude oil that contains a large number of identifiable compounds that can typically be 250 in number. These compounds can be identified and compared to the available petrol from major oil companies and suppliers.
 - c) Unless otherwise stated, or the distinction is made between leaded and unleaded petrol, major gasoline fuel shall meet the following; Acceptance levels for Octane numbers will be determined at 95% confidence level. Only additives to this motor gasoline fuel solely for the purpose of lead replacement are allowed.
 - d) Lead Replacement Gasoline, LRG, also known as LRP. Only additives from Sodium, Phosphorous, Potassium, or Manganese according to manufacturer's recommendations are allowed. Note; Manganese can enhance octane values in any petrol. Under no circumstances will values in excess of 0.005 grams/litre be permitted.
 - i. Lead in excess of EU directive 98/70EC requirements is illegal.
31. We reserve the right to amend the detail of the above specification to reflect any change occurring in the quality of the fuel on sale to the general public at any time.

32. Roadside fuel consistency when testing fuel samples.

| | BS EN 228 | BS 7800 | BS 4040 | LRG/LRP | Test Standard |
|-----------------------|------------------|----------------|----------------|----------------|----------------------------|
| Motor Oct No (max) | 89.0 | 89.0 | 89.0 | 89.0 | ASTM D2700/86 |
| Mon (min) | 85.0 | 86.0 | 86.0 | 86.0 | ASTM D2700/86 |
| Research Oct No (max) | 100.0 | 100.0 | 100.0 | 100.0 | ASTM D2699/86 |
| Ron (min) | 95.0 | 97.0 | 97.0 | 97.0 | ASTM D2699/86 |
| Lead (max) | 0.005 | 0.005 | 0.15 | | ASTM D3341 / IP362 |
| Lead (min) | ASTM D3237 | ASTM D3237 | | 0.005 | ASTM D3237 / D3341 / IP362 |
| Density @ 15° | 0.720 - 0.775 | 0.720 - 0.775 | 0.720 - 0.775 | 0.720 - 0.775 | ASTM D1298/ D4052 |
| Oxygen % max | 2.7% w/w | 2.7% w/w | 2.7% w/w | 2.7% w/w | Elemental |
| Nitrogen % max | 0.1% w/w | 0.1% w/w | 0.1% w/w | 0.1% w/w | ASTM D4629/ IP379 |
| Benzene % max | 1.0% v/v | 1.0% v/v | 1.0% v/v | 1.0% v/v | EN238 |
| Sulphur | 150mg/kg | 150mg/kg | 150mg/kg | 150mg/kg | EN ISO 14596 / ASTM D2622 |
| Olefins* | 18% v/v | 18% v/v | 18% v/v | 18% v/v | ASTM D1319 |
| Aromatics* | 42% v/v | 42% v/v | 42% v/v | 42% v/v | ASTM D1319 |

* Olefins and Aromatics values are expressed as a percentage of total fuel.

32. FUEL CELL : 600 RACING-approved fuel cells (plastic or metal) must be stock as delivered by U.S. Legend Cars International and must remain in the stock location. Metal fuel cells must be bolted through bolt holes in steel can. Foam is mandatory in all fuel cells as delivered by U.S. Legend Cars International (cars are not permitted on the track without foam in the fuel cell). The red plastic fuel cell with the 5 5/8" cap or larger is no longer allowed. Fuel Cap -Make absolutely sure that you check the cap on your fuel cell for tightness before going onto the race track. The cap should fit snugly into the cell. The car number must appear on fuel cell cap. Fuel Cooling Devices -Fuel cooling devices of any kind are not permitted on the car at any time. ***Fuel cell protection plates are mandatory. An aluminium cell protection plate must be fitted to the rear of the cell protection frame. Minimum size to be 330mm x 330mm x 3mm thickness.***
Fuel outlet must be from top of tank.

33. FUEL FILTER : Aftermarket fuel filters may be used. No glass fuel filters will be permitted. Fuel filters are not permitted in the engine compartment.

34. FUEL LINES : Fuel lines may not be located in or run through the driver's compartment of the frame. Steel braided fuel lines are mandatory. Fuel lines may not be attached to or come in contact with the electrical wires.

35. FUEL SHUT-OFF VALVE or FUEL REGULATOR : Aftermarket fuel shut-off valves and fuel regulators are permitted. A breather which must incorporate a one-way valve, must be fitted.

36. GAUGES : Analog Gauges that record or display the following information only are permitted - cylinder head temperature, RPM, oil pressure and oil temperature. Digital gauges are not permitted with the exception of stock gear indicators,

Longacre and Intercomp lap timers, Lapceivers (By Raceceivers), and Fastach Digital Tach (By SenDec, Corp.) as delivered by U.S. Legend Cars International. No other information to include, but not limited to, wheel spin, shock travel, exhaust gas 50 temperature, throttle position or G-force, will be allowed at any time. On-board telemetry systems are not permitted. Direct reading oil temperature and oil pressure gauges must use steel braided lines, not plastic or rubber. The Koso digital / analog gauge (as delivered by US Legend Cars International Inc.) is permitted to be used at all 600 RACING sanctioned events.

37. **GEAR RATIOS** : Only rear end gear ratios from a 2:50 to 4.30 are permitted. The gears must remain within the stock dimensions, steel thickness, location and configurations as delivered new by U.S. Legend Cars International.
38. **GENERAL APPEARANCE OF THE CAR** : All competitors must present a neat, clean and stock appearing car for any sanctioned competition. Crash damaged cars must be repaired to the minimum technical standards before returning to competition. The Steward of the Meeting may deny a car from competing if it does not meet the minimum acceptable standards as mentioned above. The promotion via the Steward of the Meeting reserves the right to deny access in competition because of a sponsorship, advertisement, paint scheme and/or lettering on a car not in "good taste," or in the spirit of keeping this a family sport.
39. **GRILLE** : The steel grille must remain within the stock dimensions, height, steel thickness, location and configurations as delivered new by U.S. Legend Cars International and may not be reinforced in any way. The grill used must be the same model of the bonnet, grille shell & front wings that are used. Only wire screens are permitted to enclose the grill area (i.e. for dirt tracks to keep out mud and dirt). Duct tape or any other type of material other than a wire screen is not permitted to enclose the grill area. Grille brackets (to the frame) must remain stock. Altering the brackets to raise or lower the grille is not permitted.
40. **GUSSETS** : Strengthening gussets may only be added in the spots as described in the APPENDIX. No stock gussets may be removed. REF:- Diagram 06
41. **HEIM ENDS** : Only magnetic steel heims as delivered new by U.S. Legend Cars International or of very similar dimensions are permitted on a Legend Car. The stock heims are designed to bend/break and absorb energy under impact. Heims may be upgraded, however under impact, the upgraded heims may not bend or break as quickly thereby transferring the impact-energy to the driver and an injury may result (i.e. broken wrist from the transfer of energy). Aluminium heims are not permitted.
42. **BONNET** : Bonnet louvers are permitted maximum 3/8" high. Holes in the bonnet or holes for louvers may not exceed 54 Square inches. Replacing the DZUS fasteners on the rear of the bonnet with bonnet pins is permitted. Raising the rear of the bonnet on these pins a MAXIMUM of 1" is permitted. The angle of the bonnet can be no more than 4 degrees as measured in comparison with the sub-frame of the car. While the car is on the track the bonnet must be secure and may not move up or down on the pins. Air ducts may be used on the inside of the bonnet as long as the duct does not direct airflow onto the carburetors or air filters. Bonnet

louvers may not direct air to the carburetors or air filters. The 1934 Chevy and Ford bonnets are 26" to 27" in length and may not be shortened. The 1937 Chevy and Ford bonnets are a minimum of 32" in length.

43. **IGNITION SYSTEM** : The complete ignition/engine control system must be the original OEM parts for the Yamaha FJ1200/XJR1200/XJ1250. Electronic throttle (traction) controls are not permitted. In-line fuses only are permitted (no fuse blocks are permitted). Ignition pickup coil wires must run directly to the ignition box and may not be taped or tie wrapped to other wires. No open wires or unused connectors allowed within reach of the driver. Ignition Control box -The stock FJ1200/XJR1200/ XJ1250 ignition control box (black box) or the red ignition box (marked 600 RACING-Approved and delivered by Legend Cars International) are the only boxes permitted to be used and they may not be altered or relocated in any way. Only one ignition box is permitted on a car (multiple boxes are illegal). The original stock FJ1200/XJR1200/XJ1250 rev limiting system must be in proper working condition and may not exceed 10,500 rpm. Swapping of Ignition Control boxes -600 RACING reserves the right to provide a substitute ignition/engine control system to any competitor at random at any time. The 600 RACING provided system will be exchanged for a competitors system and must be used for that event. 600 RACING is not responsible for any engine failure due to a provided ignition/engine control system. Coils, Coil Wires and Spark Plug boots -These components must be stock Yamaha FJ1200/XJR1200/ XJ1250 (sealed) parts, Taylor coil wires or grey Dynatek coil wires or red Dynatek coils marked with the 600 RACING logo as delivered by U.S. Legend Cars International. The spark plugs may be replaced with any aftermarket type with similar thread size. Resistors must remain in spark plug wire ends. Coil Mount -The "stock" coil mount may not be modified in any way and may only be replaced with a 600 RACING approved coil mount. Ignition Rotors -The ignition rotor must be a stock Yamaha FJ1200/XJR1200/XJ1250 (sealed) part or the rotor delivered with the "600 RACING approved" red ignition control box as currently delivered by U.S. Legend Cars International. No aftermarket electronic ignition advancers are permitted. Ignition Plates -The ignition plate must be a stock Yamaha FJ1200/XJR1200/XJR 1250(sealed) part or the plate delivered with the "600 RACING approved" red ignition control box as currently delivered by U.S. Legend Cars International. It may be slotted to advance the ignition timing of the engine. The ignition pickup cover is not mandatory.
44. **JAM NUTS** : At least one jam nut is required to be used with all radius rods and ball joints. One or two (minimum 1/4" maximum 7/16") jam nuts are permitted on the upper and lower ball joints.
45. **LOWER CONTROL ARMS** : The lower control arms must remain stock, within the stock dimensions (12.5" x 16.25"), steel thickness, location, and configurations as delivered new by U.S. Legend Cars International and may not be altered in any way. Each measurement will have a tolerance of +/-1/8" (0.125").
46. **MIRRORS** : A minimum of 2 rear view mirrors must be fitted (one each side of the vehicle).
47. **MUFFLERS** : Please refer to Rule 22

49. **NERF BARS** : The nerf bars must remain within the stock dimensions, steel thickness, location and configurations as delivered new by U.S. Legend Cars International and may not be reinforced in any way. No other types of nerf bars are permitted. Nerf bars may not be used to hold ballast. REF:- Diagram 07
50. **NUMBERS** : The car must have numbers that are a minimum height of 16" on both doors and 18" on the roof (number facing towards the outside of the track). The car number (minimum 3" high) must be on the right front wing. If two drivers show up at a track with the same number, the race director will determine number assignment. The size, colour and style of numbers must be adequate to permit prompt identification by track officials at all times. Roof and door numbers must not slant more than 30 degrees from vertical. Foil and reflective numbers will not be permitted. Violation of the above number rules will not be reason for disqualification. However, if the above number rules are not followed, your car may not be scored. Divisional Decals - (MANDATORY) each car must have a divisional decal ("P" for Pro, "M" for Masters or "S" for Semi-Pro, "Y" for Young Lions) on the left front wing.
51. **OIL ADDITIVES** : Any competitor caught using any of the following additives in the engine oil may be banned from all sanctioned events: hydrazine, toluene, dinitrotoluene, dioxane, propylene oxide, nitropropane or any additives determined by the technical inspector to be hazardous.
52. **OIL CATCH CANS** : An oil catch can must be fitted. It must be securely fastened and remain within the engine compartment. It may only be routed to by ONE hose from the stock crankcase breather opening or the oil fill cap.
53. **OIL COOLERS & LINES** : Oil coolers must be cooled by air only (no dry ice systems or other type). All oil cooling systems (including lines) must be mounted in the engine compartment only. No oil coolers or lines may be mounted in the drivers' compartment or in the rear deck. More than one oil cooler is permitted. Oil cooler fans are permitted. Push-lock fittings are permitted. Oil coolers may not be mounted below the bottom of the front bumper. Aftermarket oil coolers are permitted. Oil Cooler Scoops -Oil cooler air scoops (with a max. wall thickness of 1/8" sheet metal) must fit completely between frame rails and may not extend below or attach to the stock front bumper. Overhead Oiling Systems -Aftermarket overhead oiling systems for the camshafts are permitted.
54. **OIL CRANKCASE BREATHER** : The only locations that the crankcase may have a breather are under the carburetors at the stock outlet or in the oil fill cap. Only one of the above locations may be used with one hose connecting the engine breather to the catch tank. This breather may not be evacuated through the exhaust pipe (header). There may not be any additional breather holes for the crankcase. Breathers and hoses must remain within the engine compartment. Baffles used in the hoses are permitted.
55. **OIL FILTERS, REMOTE** : Remote oil filters are permitted and must be mounted in the engine compartment only. Inside or outside mounting of the remote oil filter to the frame rail is permitted. The remote oil filter must be located in a position where

it cannot be easily damaged in the event of an accident. Remote oil filters may not be mounted below the bottom of the front bumper. Filter must have a hose clamp around it, safely wired to the mount (to prevent it from "backing off").

56. **PICKUP POINTS & SPACERS** : Absolutely no modifications of the frame pickup points, rear end pick up points or spindle points are permitted. A maximum total of $\frac{3}{4}$ " wide spacer(s) may be used on all $\frac{1}{2}$ " suspension bolts. Rear shear brackets next to the rear pick up points are allowed as stated in the 600 RACING technical bulletin, dated March 2014. The distance between the bottom 'A' arm pickup and the top link pickup on the front suspension will be 7 to 7 $\frac{1}{4}$ inches.
57. **RACK & PINION STEERING** : Only the rack & pinion steering box as delivered new by U.S. Legend Cars International and stamped 600 Racing, 600 RACING (or Mid-State Machine) is permitted. A Stiletto-brand or unmarked rack & pinion steering box is not permitted. The rack and pinion mounting plate measures 3 $\frac{7}{8}$ " to 4" from the bottom of the frame rail to the top of the mounting plate (see diagram on page 96). A 4"x 4" x $\frac{1}{8}$ " plate will be allowed to be bolted (not welded) under the steering rack mounting plate. This will be a 4"x 4" x $\frac{1}{8}$ " plate with three holes using the steering rack studs to secure it. A $\frac{1}{4}$ " thick steering rack plate is permitted (as delivered by USLCI).
58. **RADIOS PROHIBITED** : No drivers or crew members are permitted to use one-way or two-way radios on race day, including practice sessions. Radio wiring harnesses are not permitted in a Legend Car during sanctioned competition. Radio ear plugs are not permitted. Racecievers at all ORCi events and must be in working order. Failure will result in exclusion from the race.
59. **RADIUS RODS/PANHARD BAR** : The radius rods and panhard bar must remain within the stock dimensions (radius rods – 6.0", 6.5", 11.0" or 12.0" in length / panhard bar - 23.5" in length), aluminium thickness, location, and configurations of the original, as delivered new by U.S. Legend Cars International. Each length measurement will have a tolerance of $\pm\frac{1}{8}$ " (0.125"). Steel radius rods or panhard bars are not permitted. The 11.0" and 12.0" rods may be interchanged anywhere on the car as long as the car still meets all other specifications contained in this rulebook. Radius Rods must be bolted between the mounting brackets on the rear axle and NOT on the side of the bracket. If collets or washers are fitted they must be symmetrical to either side of the rose joint the same. Top link arm on the rear axle can have one or two spacers upto a maximum of $\frac{3}{4}$ inch in total between the mountain brackets. Panhard bar pick-up point should be 3 $\frac{1}{2}$ to 3 $\frac{7}{8}$ inches from the top of the frame rail.
60. **REAR AXLES** : The long and the short rear axles must remain stock, within the stock dimensions, steel thickness, location and configurations as delivered new by U.S. Legend Cars International and may not be reinforced in any way. One piece axles must be delivered by U.S. Legend Cars International. Any type of aftermarket axle, an axle modified for lightening purposes, or axles not in accordance with the above rule will result in an immediate disqualification and confiscation of the illegal parts. REF:- Diagram 08

61. **REAR ENDS/DIFF** : Only 10 bolt pattern/wide flange (5/8") Toyota, locked-steel rear ends are permitted. All rear end components, to include the housing, and pickup points must meet the specifications of the stock components as delivered by U.S. Legend Cars International. The rear end must be locked (all spider gears welded or steel spool of a minimum 6.0 pounds, 5.25 pounds for a 2:50 spool, as delivered new through U.S. Legend Cars International only). No limited slip differentials, aftermarket differentials, quick change rear ends, floaters, homemade or otherwise are permitted. Only OEM bearings are permitted. No hemispheric, ceramic coated or similar type bearings are permitted. No spacers are permitted between the backing plate and bearings. Axle tube material must be 3" O.D. and .120" wall thickness. "Double shear" rear end housing is available through U.S. Legend Cars International. (Competitors are allowed to up-grade to the stock U.S. Legend Cars International "Double shear" specifications). Axle bearing flanges are square to the centre line of the rear end housing. REF:- Diagram 08
62. **RIDE HEIGHT** : The car may have no less than 3 ½ inches (1/8" tolerance) between the bottom of the frame rails (not the weld) and the ground. This measurement is to be checked without the driver in the car, as raced, without lifting of the car of any kind. (The 1/8" tolerance is allowed for movement during a race. If a car is checked before a race there is no 1/8" tolerance).
63. **RUNNING BOARDS** : The running boards must remain within the stock dimensions, steel thickness, location and configurations as delivered new by U.S. Legend Cars International and may not be reinforced in any way.
64. **SHEET METAL** : The minimum thickness of sheet metal is .036". The rear deck sheet metal (including the package tray behind the driver) may not be removed or altered in any way unless a fuel cell access hole is used. The fuel cell access hole must be covered with a sheet metal plate and secured at all times when the car is on the track.

Rule Bulletin #32816-1 LEGEND CAR DASHBOARD

Dashboards are required in all Legend Cars. As per this rule book, Legend Cars are intended to remain stock as delivered by US Legend Cars International & all cars come from the factory with a dashboard. The dashboard must be a minimum of 24" (across) X 5" (tall). It can be made out of aluminium, steel, plastic or Lexan (no carbon fibre). The material used must be a minimum thickness of .036" & a minimum weight of .50 lbs.

65. **SHOCKS** : Legend cars must use 600 RACING logo stamped, Legends, Bilstein shocks. Shock numbers must be made visible at the request of the technical inspector. Shocks maybe turned upside down. The upper part of the rear shock maybe mounted inside or outside the frame. Shock bumpers are permitted (maximum 1/4" tall). Modify/altering the shock or shock fluid or internal components is not permitted. Competing with a modified or altered shock absorber will result in disciplinary action.
REF:- Diagram 09 (Shock Tower)

66. **SHIFTER & SHIFT LINKAGE** : Shifter linkage must be Stock. Maximum height of the shifter handle is 15" as measured from the top of the drive shaft tunnel to the top of the shifter handle.
67. **SPINDLES** : The Aluminium spindles (and pickup points) must remain stock, within the stock dimensions, thickness, location and configurations as delivered by U.S. Legend Cars International. Repairing a broken or cracked aluminium spindle is not allowed.
68. **SPRINGS** : All Legend Cars must use 10" or 8" springs. Any spring weight combination and aftermarket springs of stock design are acceptable. Barrel springs and progressive springs are not allowed. Only one spring is permitted per shock. Spring rubbers are not permitted.
69. **SPROCKET ADAPTERS** : The sprocket adapters must remain stock, within the stock dimensions, steel thickness, location and configurations of the original, as delivered new by U.S. Legend Cars International. Set screws for the sprocket adapter nut are permitted. Lightening the sprocket adapter for weight savings in any way is illegal. REF:- Diagram 10
70. **STEERING COLUMN** : The steering shaft or steering column bracket may be modified for driver comfort or safety by altering the length of the shaft or by altering the steering column bracket that connects to the dash (if the "dash" bracket is replaced, steel brackets must be used, no aluminium). Bearings are not permitted to be used in mounting the steering shaft. Stock-style bushings or steel rod-ends must be used. Intentional lightening for weight saving measures is not permitted. A hose clamp or shaft collar is mandatory on the steering column in the engine compartment directly against the firewall. There can be no more than ¼" gap between the clamp (collar) and the bushing (See diagram in Appendix). Modification of the driver's compartment roll cage is not permitted. 56 Steering Quickeners -Steering quickeners are not permitted without special written permission from 600 RACING. Steering Shafts -Tubing used for steering shafts must be stock as currently delivered by U.S. Legend Cars International and may not be reinforced in any way. Upgraded steering joints are acceptable.
71. **STEERING WHEELS** : Larger or smaller steel or aluminium steering wheels are allowed. Racing style, quick release steering hubs are mandatory.
72. **TYRES** : The Legend formula has one tyre regulation which is the 22.5 x 7.0 x 13.0 Spedeworth. The current price can be found by contacting Hoosier Tires on 01293 863579.

Tyre softener or any tyre contamination is not permitted. Tyres will be randomly durometer checked.

Tyre Ruling:- ***One new tyre every other meeting that you race at.*** The tyre can be banked but must be logged along with any four old tyres that have being previously used and declared (except at Arlington Stadium, Eastbourne where you may use more old tyres if you are not using a new one). These used tyres must appear within the drivers history.

New drivers may use four new tyres for their first meeting but must start at the rear of the grid for two meetings. On the third meeting they can declare a new tyre in the normal way.

If found with the wrong tyre number on the car which does not correspond with the tyre sheet or logging system this will result in being loaded from the meeting, losing the days points and a one points scoring meeting ban.

Tyre sharing is not permitted unless the tyre has been declared and used at three previous meetings. You must also declare this with the Spedeworth Head Office before the meeting.

All drivers must register on the drivers tyre website:- <https://otl-drivers.co.uk>
This website must be used by all drivers to log tyres from every meeting that they attend. They have 2 days from the day of the meeting to upload their tyre log from the attended meeting. Any driver failing to upload tyres by the deadline will not be permitted to declare a new tyre at the next event they attend. The website can be used by all drivers to view or search a history of a specific tyre, and the facility should be used to ensure a previously used tyre has done the adequate number of meetings before another driver can log it as USED. Where tyres have been bought from another driver this information should be left in comments box the first time you submit the tyre on the website.

Tyre logs must still be handed into the scrutineer on the day, and this must match the log submitted online. Where the event is a 2 day event, the 2 days will start at the end of the weekend (i.e. from the Sunday on a Saturday/Sunday Event).

For the first two meetings in 2024 you will be allowed to declare four new tyres only and start within your grade. If you do not attend the first two meetings on the fixture list you will be allowed to register four new tyres at your first meeting but will start at the rear of the grid for two meetings, from your third meeting you can declare one new tyre and start within your grade.

~~In 2025, you can run a 'joker' round. This means you can declare four new tyre at any round with the exception of the National Championship or British Championship.~~

73. **TRACTION CONTROL DEVICES** : No electronic or computerized wheel spin/traction control devices are permitted. Any driver caught using these devices will face penalties from probation to an indefinite suspension.
74. **UPPER CONTROL ARMS** : The upper control arms must remain stock, within the stock dimensions (4.25" +/- 1/8" in length), steel thickness, location, and configurations as delivered new by U.S. Legend Cars International and may not be altered in any way. REF:- Diagram 11
75. **WEIGHT** : The minimum weight of the car with the driver (as raced) is 1288 pounds. The minimum weight of the right side of the car (with driver as raced) is 615 pounds. The maximum rear weight percentage (without driver) is 52%. No

intentional lightening of the chassis is permitted. Competitors are not permitted to add fuel after an event to meet minimum weight. It is the responsibility of each team to ensure that their car meets the weight requirements on the scales that are to be used by the 600 RACING official.

76. **WEIGHT SAVING MEASURES** : Lightening "stock" components by shaving, milling, drilling or any other method is illegal. Any item on a Legend Car that is used (other than what is mentioned in the rules) as a weight saving method is considered illegal. Non-stock aluminium or titanium components are considered illegal and will be confiscated immediately. Components must remain the same material as delivered by U.S. Legend Cars International unless specified in this rulebook.
77. **WHEELS** : *The minimum weight of an Aero or Bassett wheel and with a Hoosier tire fitted ~~the~~ must be at least 25.0 pounds. Wheel weights are not permitted.* Bleeder or relief valves are not permitted in the wheels.
78. **WHEELBASE** : All cars must compete with 72 3/4" to 73 1/4" wheelbase on either side. Measuring wheelbase -The measurement will be taken with the front and rear tyres on one side in line with each other. To determine this, the measuring tool or tape measure must touch three points. These points are the front of the rear tire sidewall and the front and rear of the front tire sidewall. The measurement is then taken from the front edge of the front wheel to the front edge of the rear wheel. The process is the same when measuring wheelbase on the opposite side.
79. **WIDTH** : The total overall width of the car (front and rear) may not exceed 60 inches with Federal tyres or 61 inches with American Racer tyres. The car must be able to roll freely through a 60 or 61 inch (tire brand specific) wide opening as raced.
80. **REAR OFFSET** : There must be a minimum of 6" between the inside edge of the rear brake drum and the rear frame rails (directly below the centreline of the rear-end housing) on both sides. No wheel or axle spacers are permitted. *Enforcement and Infraction Penalties of the Ride Height, Wheelbase and Width Rules: After qualifying or after a race, if a car is found to be in violation of the ride height, wheelbase or width rule, and only if requested by the driver, the driver may have five (5) minutes to find the reason why the ride height, wheelbase or width does not meet the rules. It is the driver's responsibility to find the reason (such as a bent part that would directly affect the infraction) before the car leaves the tech area. It is not the tech inspector's responsibility to find the reason. If a reason cannot be found and the car leaves the tech area, the driver cannot bring it back to the tech inspector showing or explaining a damaged part which affected the ride height, wheelbase or width. This must all be done within the tech area and within the specified time period. If no reason (such as damaged parts that would directly affect the infraction) can be found, this will result in an immediate disqualification.
81. **WINDSHIELDS/SCREENS** : All cars must have either a wire mesh screen (maximum 1" squares) or Lexan windshield in the front window area. A Lexan sun visor is also permitted in the front window. Holes are permitted in the Lexan windshield.

7. TECHNICAL SPECIFICATIONS : ENGINES

Imported engines must be sourced through the OTL dealer. Second-hand engines must be checked and sealed by an OTL engine builder.

It is the drivers responsible to ensure their engine is sealed correctly and registered with the OTL dealer. The driver must also ensure the engine number and seal numbers are noted in the drivers log book.

XJ1250 "SEALED" ***The XJ1250 & XJ1219 are sealed engines.

In the UK the following officially appointed engine builders can check and seal XJ1250 & XJ1219 engines. All engines must be sealed by the OTL engine builder with the exception of new cars brought through the UK Oval Track Legend dealer with a 1250cc sealed (600 RACING supplied) engine.

| | | |
|---|---------------|---------------|
| ✓ | John Treherne | 07568 510 221 |
| ✓ | Mike Fancy | 07801 336 531 |

Tampering, removing, altering the engine seals will result in an immediate disqualification AND WILL RESULT IN A 6 MONTH BAN. REFUSAL TO STRIP YOUR ENGINE WILL RESULT IN A 12 MONTH BAN. The cam boxes must be sealed by the engine builder for the engine builder to be responsible for the legality of your engine. Should the cam box not be sealed, the driver will be responsible for the legality of the engine and will have to serve any bans issued should the engine be found to be illegal. If an engine builder sealed engine is found to be illegal (excluding any of the bolt on accessories or any part that can be tampered with without breaking the seals) the driver will be excluded from the meeting without any further disciplinary action. The engine builder will be held responsible for the indiscretion.

The only modifications allowed to the sealed engines are:

- a) Changing carburettor jets
- b) All stock carburettor adjusters may be used
- c) Adjusting the valve shims
- d) Installing an aftermarket clutch and spring of original design (no aluminium clutch plates).
- e) Upper head oilers, heavy-duty valve springs, "pinned" camshafts and steel sleeves are permitted if installed by an 600 RACING authorized sealed engine shop only.

The engine must remain a factory-stock Yamaha FJ1200/XJR1200. Only those changes as described in this section of the rulebook are permitted to be made to the FJ and XJ 1200.

If this rulebook does not specifically say that you can change/modify/add something, then you must consider that the change/modification/addition is illegal. Any questions about the legality of a change/modification/addition not covered in this rulebook must

be answered by the technical inspector. If you have a request for a change/modification/addition, please contact the technical inspector before making the change/modification/addition.

1200.01 CAM SHAFT : The cam shafts must remain as stock Yamaha FJ1200/XJR1200. The cam shaft marking ("I" and "E") may not be removed. Stress relieving by machining or polishing on the radius next to the cam gear or on the shaft is permitted. Modifying any part of the lobes (lift, profile, duration, weight, etc.) is illegal. Installation of an X" (I.D.) X W" (O.D.) piece of 4130 aircraft steel the full length of the camshaft is permitted. This is known as a pinned cam and must be purchased from the OTL dealer. REF:- Diagram 12

1200.02 CAM CHAIN : The cam chain must remain as stock Yamaha FJ1200/XJR1200 as delivered new by U.S. Legend Cars International

1200.03 CAM CHAIN ADJUSTERS : Aftermarket manual cam chain adjusters are permitted to be used on unsealed engines.

1200.04 CLUTCH : The clutch (plates and springs) may be 60 replaced with any aftermarket type of the same design (no aluminum clutch plates). Due to the rigors of road racing, a billet aluminum clutch basket will be allowed for road racing only. The basket, primary drive gear, shims and springs must weigh a minimum of 5.5 lbs.

1200.05 1200 CYLINDER HEAD : The original equipment cylinder head of an unsealed engine must remain in unaltered "as cast" condition with the exception of machining the gasket surface (no angle milling allowed). Valve seat inserts may be reworked or replaced with OEM or aftermarket seats of original dimensions. The stock I.D. at the bottom 1/16 of an inch is 0.990" for the intake port and 0.830" for the exhaust port. No port alterations of the intake or the exhaust below the seat are permitted. O-ringing the head gasket seal area is not permitted. Combustion Chamber -Relief cuts for cc balancing may not exceed the bore size. Repairing Heads -A combustion chamber may be repaired by welding and grinding back to the official "stock" configuration of the combustion chamber.

1200.06 1200 COMPRESSION RATIO : The compression ratio of an unsealed engine may not exceed 10.0:1 (no tolerance) If the compression ratio is found to be over 10.0:1, it will result in an immediate disqualification and confiscation of all of the following parts: the entire upper end (including the head, the valves, the head gasket, etc.) as well as the pistons and cylinder casings (including base gasket). Upon rebuild, only the following things may be done to meet this rule: machining the piston domes, machining the gasket surfaces of the cylinder head and/or cylinder casings.

1200.07 CRANK SHAFT : The crank shaft must remain as stock FJ1200/XJR1200 as delivered new by U.S. Legend Cars International. Modifying the throw balances or weight of the crank is illegal. Polishing the crankshaft is illegal. Minimum crankshaft weight will be 27 pounds.

1200.08 1200 CRANKING COMPRESSION : The cranking compression of an un-sealed engine must be at or below 165 P.S.I. at any time (hot or cold) on at least three (3) cylinders with the ignition off, the throttle wide open, and with the carburetors on the engine. A minimum of ten to twelve revolutions of the engine will determine the total compression of a cylinder. Cam timing may be adjusted accordingly to meet the requirements of this rule by slotting the cam sprocket gear or substituting with an aftermarket cam gear sprocket. 600 RACING highly recommends that you have your engine set at 155lb cranking compression instead of right on the line at 165 lb. to allow for slight variations between gauges. There is no tolerance for engines over 165 lb. The gauge used by the tech inspector is the "official **gauge. JI**

1200.09 OIL PAN : The stock oil pan may not be altered, modified or include any additions to alter the path of the oil.

1200.10 OIL PUMP : The stock oil pump may not be modified in any way. Relief valves may be shimmed.

1200.11 1200 PISTONS & RINGS : The cylinder bore of an un-sealed engine may not exceed 77.57mm or 3.054" (maximum .022" overbore from stock). Only Yamaha pistons (part #1TX 11631-00 and #1TX 11636-00) or forged Wiseco pistons (part #K1188, #L1195, #L1199 and #L1202) may be used. Only Yamaha rings (part #1TX 11610-00 and #1TX 11610-20) or Wiseco rings (part #21- 3041X9 and #21- 3051X6) may be used. These rings may not be altered in any way. The ring lances and lower part (skirts) of the piston may not be altered from the original in any way. Gas-porting the pistons are not permitted. Wrist pin buttons may be used. Cylinder Sleeves -Worn cylinder sleeves may be replaced with aftermarket sleeves.

1200.12 1200 RODS: The rods in an un-sealed engine must remain as stock FJ1200/XJR1200. Rod bolts may be changed to any aftermarket type. Only shot peening the rods is permitted (no polishing by any means is permitted). Weight balancing to the lightest unaltered rod is permitted. All dimensions must be stock. XJ1250/1300 connecting rods are not allowed in an un-sealed engine.

1200.13 STROKE : The stroke must remain stock for the FJ1200/XJR1200 Yamaha.

1200.14 1200 VALVES : Only stock Yamaha FJ1200/XJR1200 valves are permitted. No modifications are permitted to the valves with the exception of altering the number of angles of the seat and a maximum back cut width up to 0.200" is permitted from edge of the valve. Valve jobs are permitted. Only stock valve lifter and adjuster shims may be used.

1200.15 VALVE GUIDES : The valve guides must remain the same size, length and location of the current "stock" valve guides. The guides may not be altered in any way. Shot peening of valve guides are not permitted. Brass aftermarket valve guides of the same dimensions of stock may be used.

1200.16 VALVE SPRINGS : The valve springs may be replaced with aftermarket

magnetic steel springs. Only stock steel valve spring retainers and clips/keepers are permitted. No titanium or other lightweight alloys are permitted.

1200.17 TRANSMISSIONS : The transmission and transmission gears must remain stock Yamaha FJ1200/XJR1200/XJ1250 (sealed) in the stock configuration as delivered by U.S. Legend Cars International. They may not be lightened in any way. The transmission gears may be shimmed only for the purpose of proper engagement. Standard and aftermarket shims may be utilised.

1200.18 ENGINE SPECIFICATION RULES FJ & XJ 1200 : The unsealed engine must remain factory-Stock Yamaha FJ1200/XJR1200. Only those changes as described in the rulebook are permitted to be made to the FJ1200 and XJR1200. A Yamaha FJ1200/XJR1200 manufactured for other countries (Canada, England, etc.) or an FJ1100 may be used if it meets all the standard Yamaha specifications.

If this rulebook does not specifically say that you can change/modify/add something, then you must consider that the change/modification/addition is illegal.

Any questions about the legality of a change/modification/addition not covered in this rulebook must be answered by the promotion in writing and presented to the tech inspector upon request. If you have a request for a change/modification/addition, please contact the promotion before making the change/modification/addition.

Engine Type: Air cooled 4-Stroke gasoline

Carburetor: Bs36 X 4 Mikuni

Displacement: 1,188 cm³ (maximum 1,203 cm³ permitted)

Bore: 77.0mm (3.032 in.) with a maximum .022 in. overbore permitted.

Stroke: 63.8 mm (2.512 in.)

Compressions Ratio:- 9.7:1 (maximum 10.0:1 permitted)

Starting System: Electric Starter

Cam Shaft: Intake "A" 35.95 to 36.05 mm (1.415 to 1.419 in.) Minimum limit 35.85 mm (1.411 in.) Intake "B" 28.25 to 28.35 mm (1.106 to 1.116 in.) Minimum limit 28.15 mm (1.106 in.) Exhaust "A" 35.95 to 36.05 mm (1.415 to 1.419 in.) Minimum limit 35.85 mm (1.411 in.) Exhaust "B" 28.25 to 28.35 mm (1.106 to 1.116 in.) Minimum limit 28.15 mm (1.106 in.)

DIAGRAM OF CAM SHAFT LOBE

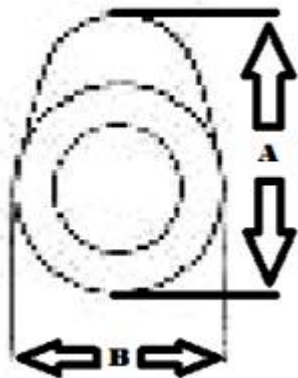

Cam Chain: Type/# of lobes 79RH2015 (Silent Chain)/156 links. Adjustable method Automatic (Manual is permitted).

Valves: The only permitted machining of the valve seats angles are; 75-60-45-15, 70-60-45-30, 60-45-30, 60-45-15. The seat width minimum is 0.030 thou.

Head Diameter: Intake 28.9 to 29.1 mm (1.138 to 1.146 in.) Exhaust 24.9 to 25.1 (0.980 to 0.988 in.)

Stem Outer Diameters: Intake: 5.475 to 5.490mm (0.2156 to 0.2161 in.) Minimum limit: 5.445 mm (0.1244 in.) Exhaust: 5.460 to 5.475 mm (0.2150 to 0.2155 in.) Minimum limit: 5.430 mm (0.2138 in.)

Valve Guide Inside Diameters: Intake: 5.500 to 5.512 mm (0.2165 to 0.2170 in.) Maximum limit: 5.550 mm (0.219 in.) Exhaust: 5.500 to 5.512 mm (0.2165 to 0.2170 in.) Maximum limit: 5.550 mm (0.2190 in.)

Transmission: Type: Constant mesh, 5-speed. Gear Ratio: 1st -40/14 (2.857 2nd -36/18 (2.000) 3rd -33/21 (1.571) 4th -31/24 (1.291) 5th -29/26 (1.115)

RULE CLARIFICATION & ENGINE SPECIFICATION FOR 1250 SEALED ENGINES

These engines will have the following serial numbers:-

- ***P501E***
- ***P502E***
- ***P503E***
- ***P506E***
- ***P508E***
- ***P515 Injection (with the cam shafts changed to non-injection specification).***

1250.00 Only cam shaft Yamaha part number 5EA-12171-00 (inlet) and 5EA-12181-00 (exhaust) are allowed. Both cam timing dots must be visible in cam cap window at TDC. The only cam shaft timing wheels permitted are for the carburettor specification cam shaft, cam wheels from injection shafts are not allowed.

1250.01 No slotting, oversize drilling or cam gear bolt holes, only cam bolt part number 90105-06424 may be used.

Camshaft lobe dimensions

Intake A 35.950-36.050 mm Limit 35.850 mm

Intake B 28.058-28.158 mm

Exhaust A 35.950-36.050 Limit 35.850 mm

Exhaust B 28.045-28.145 mm

REF:- Diagram 12

| Degree | Manufacturers | Tolerance |
|--------|---------------|-----------|
| 0 | 8.04 | 8.04 |
| 5 | 7.95 | 7.99 |
| 10 | 7.69 | 7.87 |
| 15 | 7.40 | 7.61 |
| 30 | 5.79 | 6.05 |
| 45 | 3.40 | 3.64 |
| 60 | 0.66 | 0.84 |
| 75 | 0.20 | 0.26 |
| 90 | 0.05 | 0.09 |
| 105 | 0 | 0 |

REF:- Diagram 12

1250.02 Cylinder deck to piston heights must be a minimum of 0.013 thou, with a nominal cylinder height 3.475 inches. In conjunction with a Standard Yamaha steel base gasket part no 5EA-11351-00 (0.010 thou thickness gasket) or a Cometic Copper base gasket (0.005 to 0.020 thou thickness gasket) will give the required piston to achieve minimum deck clearance. Bore and Stroke, 79.0 x 63.8mm displacement 1251 cm³. Cylinder deck to position height will be measured with the cylinder clamped in position.

1250.03 Only standard Yamaha pistons part number 5EA-11351-00 or Legends edition Wiseco pistons up to 0.008 thou oversize are permitted.

1250.04 Only standard Yamaha or Wiseco piston rings maybe used. No total seal piston rings are allowed.

1250.05 The only permitted machining of the valve seats angles are; 75-60-45-15, 70-60-45-30, 60-45-30, 60-45-15. The seat width minimum is 0.030 thou.

Valve head diameter (intake) 28.90-29.10mm, (exhaust) 24.90-25.10mm
Valve face width (intake) 1.980-2.550 mm, (exhaust) 1.980-2.550 mm
Valve seat width (intake) 0.90-1.10 mm, (exhaust) 0.90-1.10 mm
Valve stem diameter (intake) 5.475-5.490 mm, Limit 5.445 mm
Valve stem diameter (exhaust) 5.460-5.475 mm, Limit 5.430 mm
Valve guide inside diameter (intake) 5.500-5.512, Limit 5.552 mm
Valve guide inside diameter (exhaust) 5.500-5.512 mm, Limit 5.552 mm
Valve stem to valve guide clearance (intake) 0.010-0.037 mm, Limit 0.080 mm
Valve stem to valve guide clearance (exhaust) 0.025-0.052 mm, Limit 0.100 mm
Valve stem runout 0.010 mm

1250.06 No enlarging of the seat inside throat diameter.

1250.07 The valve must be standard Yamaha part number 36Y-12111-00 and 36Y-12121-00

1250.08 Heavy duty valve springs maybe used with a maximum installed pressure of 68psi.

1250.09 Only XJ 1250 series heads maybe used. (No FJ1200 series heads). Cylinder heads are not interchangeable.

1250.10 Cylinder head re-surfacing is allowed, but additional base gaskets will be required to ensure that a compression ratio of 10:1 is not exceeded.

1250.11 Cylinder head CC in standard form is 33.2cc to 34.2cc any variants below this will require additional gaskets to be fitted.

1250.12 Internal components cannot be polished, bead blasted, shot peened.

1250.13 All other components to be stock Yamaha parts.

1250.14 An alternative to heavy duty cylinder head studs is permitted by way of an "inverted top hat" inserted and none stock cylinder head nut.

1250.15 The stock I.D at the bottom 1/16 (one sixteenth) of the valve seat insert is 0.990 of an inch for the intake port and 0.830 inch for the exhaust port. No port alterations of the intake or exhaust below the seat are permitted.

1250.16 The cam shaft (one intake and one exhaust) must remain as stock Yamaha FJ1200/XJ1250 (non-injection) as and in the same location supplied by 600 racing. The cam shaft marking 'I' (Intake) and 'E' (Exhaust) may not be removed and must remain in the appropriate positions. Stress relieving by machining or polishing on the radius next to the cam gear or on the shaft is permitted. (REF:- Diagram 12)

Modifying any part of the lobes lift, profile, duration, weight etc is illegal. Aftermarket over head oiling systems for the cam shafts are permitted. Steel billet intake cams are not permitted. Installation of a ¼ " ID x ½ " OD piece of 4130 aircraft steel the full length of the cam shaft is permitted. This is known as a pinned cam and must be purchased from OTL dealer.

1250.17 Unless otherwise stated within these regulations only the original stock components supplied and intended for the Yamaha FJ1200 and XJ1250 engines are allowed.

1250.18 CARBURETTORS

- i)** Changing the carburettor jets is allowed.
 - ii)** All stock carburettor adjusters maybe used.
 - iii)** Changing the main jets, idle jets and air corrector jets is allowed.
 - iv)** Changing the piston spring and metering needle is allowed.
 - v)** The emulsion tube cannot be modified in any way and must remain as standard.
 - vi)** Material cannot be moved from any part of the carburettor body piston.
- The above applies to all FJ1200 and XJ1250 carburettors.

1250.19 CAM CHAIN

The cam chain must remain as stock Yamaha FJ1200/XJ1250 and can be supplied by 600 racing.

1250.20 CAM CHAIN ADJUSTERS

After market manual cam chain adjusters are not permitted.

1250.21 CLUTCH

The clutch (plates and springs) maybe replaced with any after-market type of the same design. No aluminium or titanium clutch plates are allowed. Twin plating the original spring diaphragm plate is permitted.

1250.22 CYLINDER HEAD

The original cylinder head must remain in an unaltered as cast condition with the exception of machining the head gasket surface. Valve seat inserts maybe re-worked or replaced with OEM or after-market seats of original dimensions. The stock I.D at the bottom is 1/16" (one sixteenth) of the valve seat insert is 0.990" for the intake port and 0.830" for the exhaust port. No port alterations of the intake or exhaust below the seat are permitted. O-ringing the head gasket seal area is not permitted.

The combustion chamber maybe matched and cubic capacity balanced to the highest CC chamber which has been unaltered. Relief cuts for CC balancing may not exceed the bore size.

A combustion chamber may be repaired and grinding back to the official stock configuration of the combustion chamber. An alternative to heavy duty cylinder head studs is permitted by way of an "inverted top hat" insert and non-stock cylinder head nut.

1250.23 COMPRESSION RATIO

The compression ratio may not exceed 10.00:1 (no tolerance). Only the following may be done to meet this rule:- machining the piston domes, machining the gasket surfaces of the cylinder head and or cylinder casings.

1250.24 CRANK SHAFT

The crank shaft must remain stock Yamaha FJ1200/XJR1200/XJ1250 and can be supplied by 600 racing. Modifying the throw balances or weight of the crank is illegal. Minimum weight is 27lbs. One throw on the crank must have no balancing holes in it.

1250.25 CRANKING COMPRESSIONS

The cranking compression test method is with all the spark plugs removed with the throttle body fully open and the engine to be cranked a minimum of 10-12 revolutions to determine the cranking compression value (The engine can be hot or cold). Cranking compression value must not exceed 165lbs/sq for the FJ1200. FOR THE XJ1250 ENGINES THE CRANKING COMPRESSION MUST NOT EXCEED 175lbs/sq. On at least three cylinders with the ignition off. The scrutineer may request a change of battery if the engine does not 'turn-over' sufficiently. It is recommended that the compressions are set at least 10lbs/sq less when cold. This will allow for gauge and temperature variations.

1250.26 OIL PUMP

The stock oil pump may not be modified in any way. Relief valves may be shimmed. A sump baffle may be installed.

1250.27 PISTON & RINGS

The ring lances and lower part (skirts) of the piston may not be altered from the original in any way. Gas porting the pistons is not permitted. Worn cylinder sleeves may be replaced with after-market sleeves.

1250.28 RODS (CONNECTING)

The rods must remain stock Yamaha for the FJ1200/XJ1250 as delivered by 600 racing. Rod bolts may be changed to any after-market type. Only shotpeening of the rods is permitted. Polishing by any means is NOT permitted. Weight balancing to the lightest un-altered rod is permitted. All dimensions must be Yamaha stock FJ1200 and XJ1250. Interchanging rods is NOT permitted.

1250.29 STROKE

The stroke must remain stock Yamaha FJ1200/XJ1250 63.8 mm

1250.30 VALVES

Only Yamaha FJ1200/XJ1250 valves are permitted. No modifications are permitted to the valves with the exception of altering the number of angles of the seat and the maximum back cut width of up to 0.200" is permitted from the edge of the valve. Valve jobs are permitted. Only stock valve lifter and adjuster shims may be used.

1250.31 VALVE GUIDES

The valve guides must remain the same size, length and location. The guides may not be altered in any way. Shotpeening of the valve guides is not permitted. Brass after-market valve guides of the same dimensions of stock may be used.

1250.32 VALVE SPRINGS

The valve springs may be replaced with after-market steel springs. Only stock valve spring retainers and clips/keepers are permitted. No titanium or other light weight alloys are permitted.

1250.33 TRANSMISSIONS & GEARSHIFT MECHANISM

The transmission and transmission gears must remain stock Yamaha FJ1200/XJ1250. They may not be lightened in any way. The transmission gears may be shimmed only for the purpose of proper engagement. Standard and aftermarket shims may be used. The gear shift mechanism must remain stock part and in the original position/location and configuration supplied by 600 racing. Needle bearings are not allowed. The gear shift lever and link rod must be as per the stock part. The aluminium clamp lever on the spline shaft from the engine may be changed for the steel splined Yamaha part supplied by 600 racing and modified for length. The triangle may have a welded boss or bush added to minimise the play in this component. Needle bearings are not permitted.

1250.34 SPROCKET ADAPTER

The sprocket adapter must remain standard as supplied by 600 Racing. Boring / skimming is not permitted.

8. TECHINCAL SPECIFICATIONS : APPENDICES

LEGENDS CARS FACTORY STOCK SPECIFICATIONS

(These are some of the factory specifications. This is not a complete list of all the factory specifications. If the information you need is not listed in the rulebook, please contact U.S. Legends Cars for the correct factory specifications.)

Legends Battery Box Offset

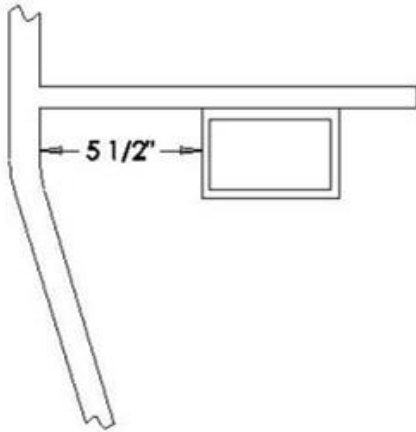

Note: The measurement for the battery box offset will be taken at the point closest to the crossmember, from the inside of the framerrail to the outside of the battery box.

Diagram 01

Legends Brake Drum

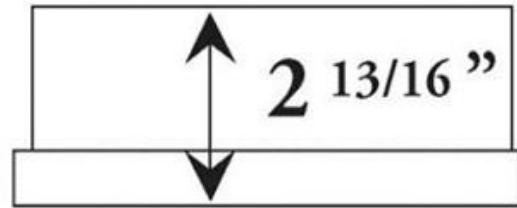

(10 lbs. Minimum)

Diagram 02

Legends Right Side Motor Mount

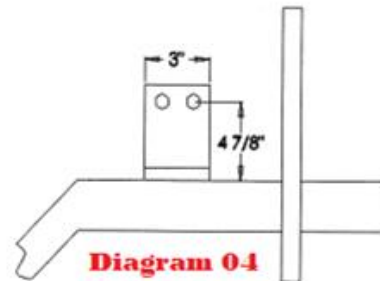

Aluminum mounts or extra holes are illegal.

Legends Left Side Motor Mount

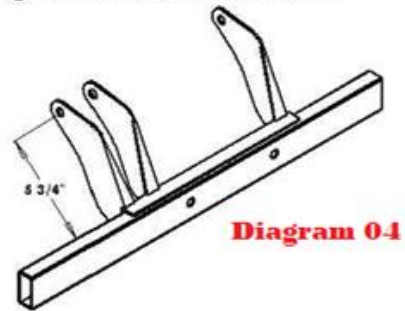

Diagram 04

Legends Front & Rear Bumper

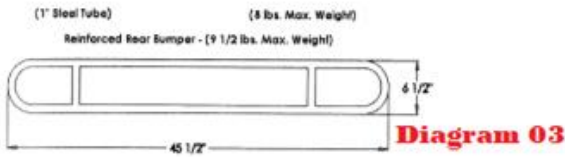

Diagram 03

Legends Left Side Motor Mount Pickup Points & Front Clip Measurements

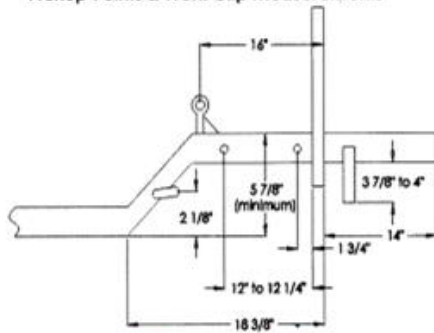

Diagram 05

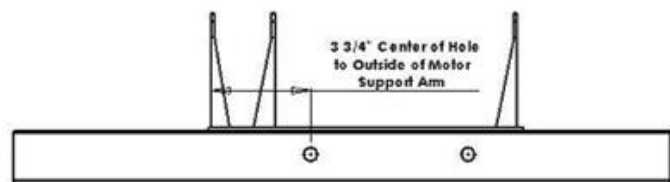

Diagram 04

APPENDIX

GUSSETS & MODIFICATIONS THAT ARE PERMITTED TO BE ADDED TO EXISTING LEGENDS CARS AND PARTS

Front Clip Support

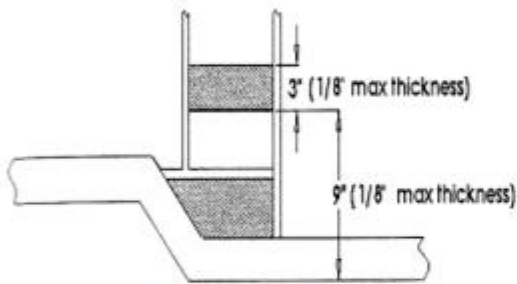

Diagram 06

Upper Link & Rear Trailing Arm Pickup Points

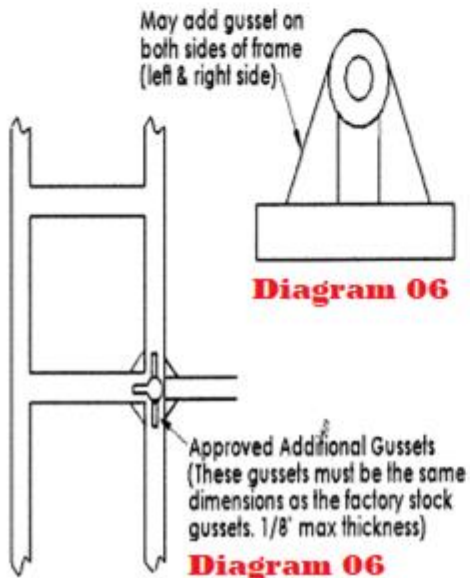
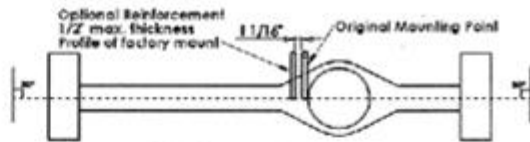

Diagram 06

Rear End Housing Upper Link & Rear Trailing Arm Pickup Point



(This reinforcement will secure the opposite side of the rod end of the upper link)

Diagram 06

Back View of Housing

Approved Rear Gusset (Max. 3/16" thick)

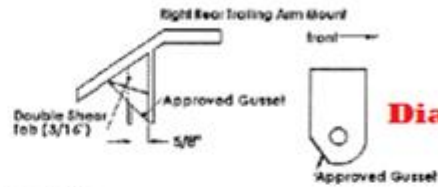

Diagram 06

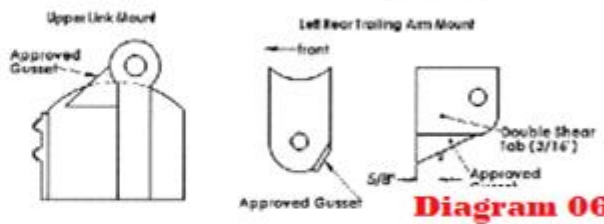

Diagram 06

Steering Rack Plate



Diagram 06

Upper Link Double Shear Mount (Chassis Side)

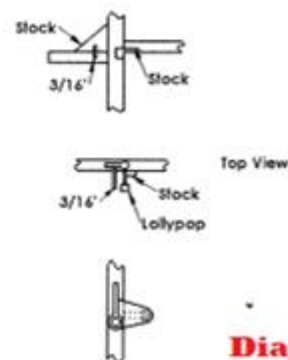

Diagram 06

APPENDIX

The long gusset for the top link pick-up on the chassis must be 9 inches in length by 1 1/4 inches in width at the top, going down to the chassis rail on the necessary diagonal angle as shown in the picture below.



Diagram 06

Legends Right & Left Nerf Bars

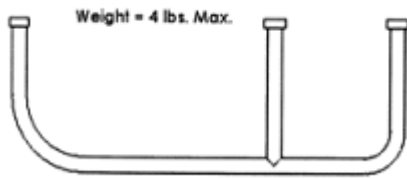

Diagram 07

Legends Rear End Housing

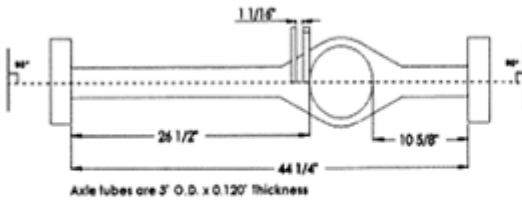

Diagram 08

Legends Axles

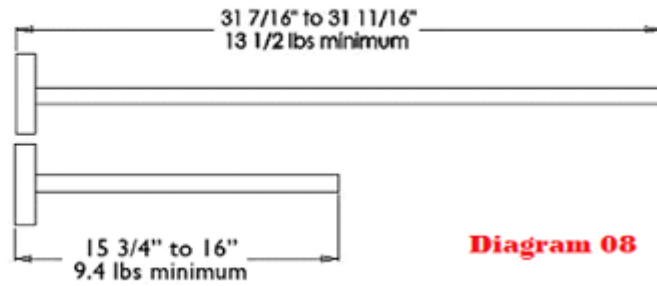

Diagram 08



Diagram 8



PANARD BAR FIXING HOLE
LOCATION DISTANCE $9 \frac{3}{4}$
INCHES MEASURED FROM
STRAIGHTEDGE AT AXLE
FLANGE TO THE CENTER OF
THE HOLE

Diagram 8

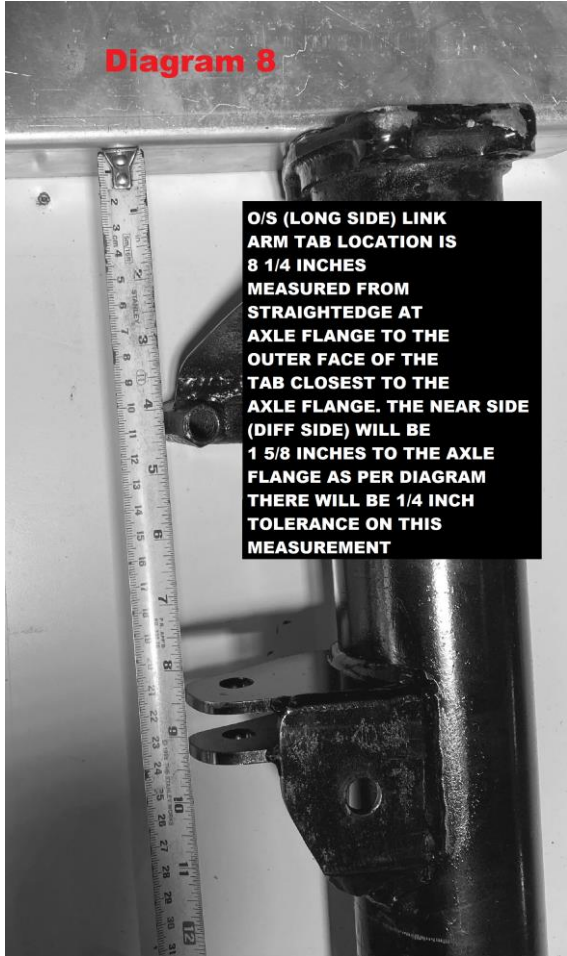
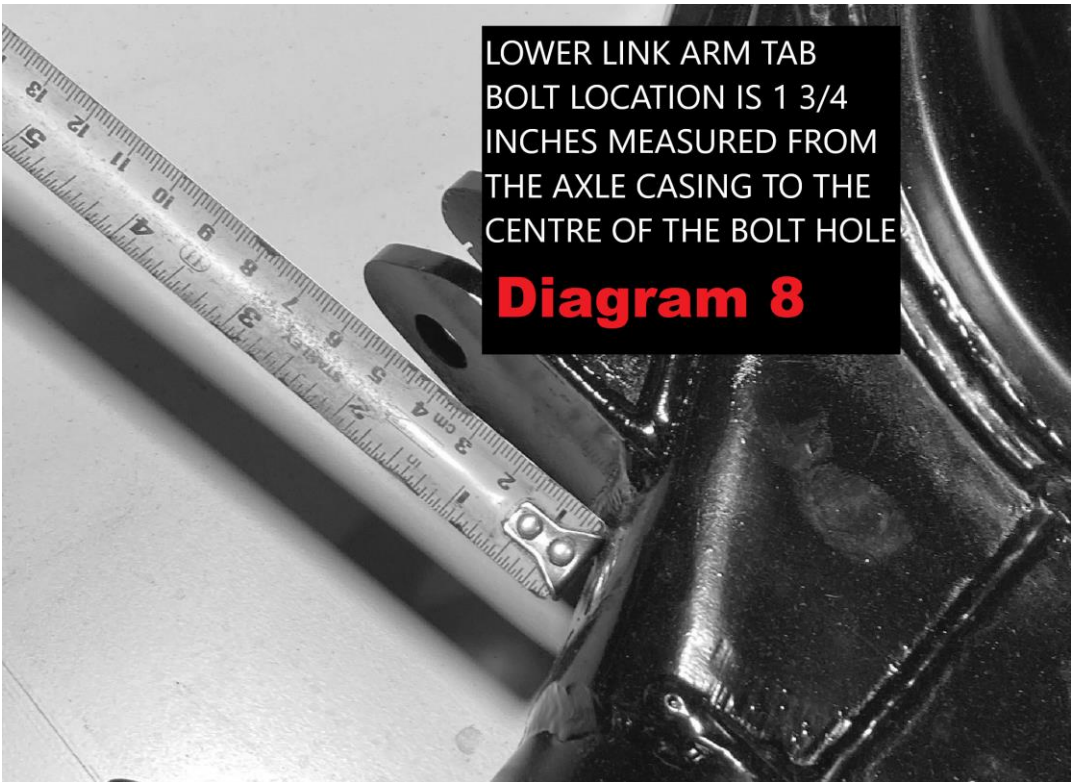

Diagram 8

O/S (LONG SIDE) LINK
ARM TAB LOCATION IS
 $8 \frac{1}{4}$ INCHES
MEASURED FROM
STRAIGHTEDGE AT
AXLE FLANGE TO THE
OUTER FACE OF THE
TAB CLOSEST TO THE
AXLE FLANGE. THE NEAR SIDE
(DIFF SIDE) WILL BE
 $1 \frac{5}{8}$ INCHES TO THE AXLE
FLANGE AS PER DIAGRAM
THERE WILL BE $\frac{1}{4}$ INCH
TOLERANCE ON THIS
MEASUREMENT



LOWER LINK ARM TAB
BOLT LOCATION IS $1 \frac{3}{4}$
INCHES MEASURED FROM
THE AXLE CASING TO THE
CENTRE OF THE BOLT HOLE

Diagram 8

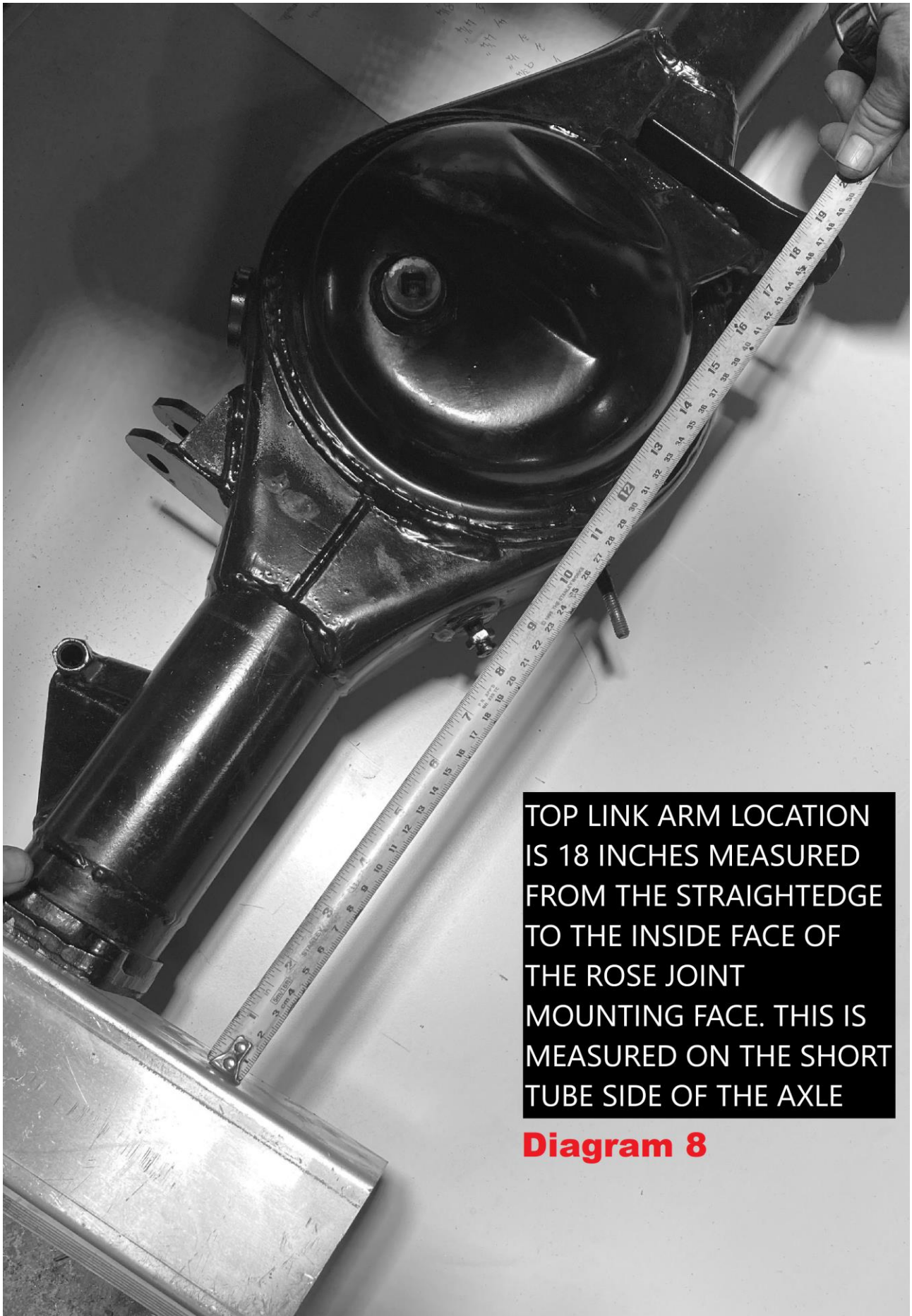

TOP LINK ARM LOCATION IS 18 INCHES MEASURED FROM THE STRAIGHTEDGE TO THE INSIDE FACE OF THE ROSE JOINT MOUNTING FACE. THIS IS MEASURED ON THE SHORT TUBE SIDE OF THE AXLE

Diagram 8

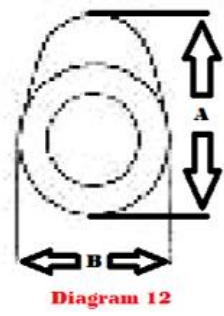
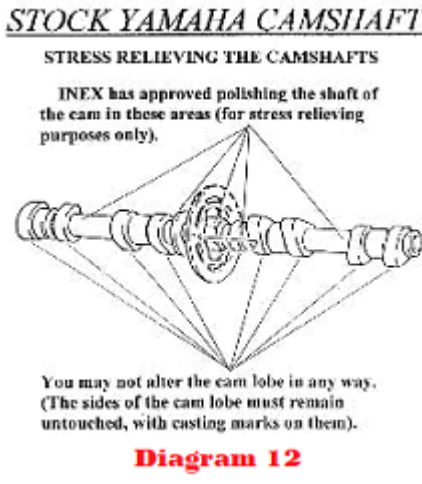
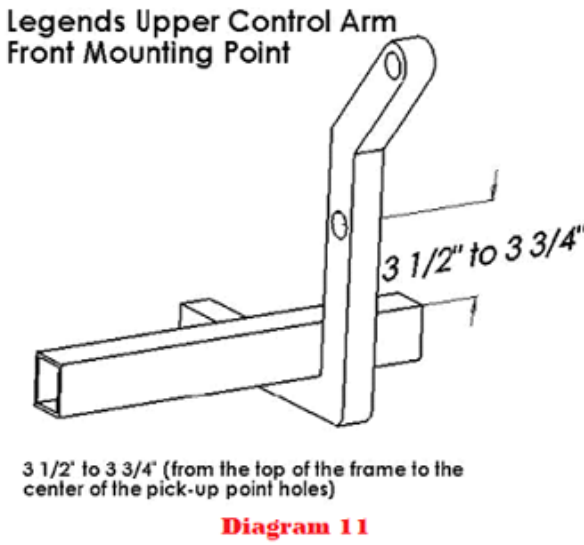
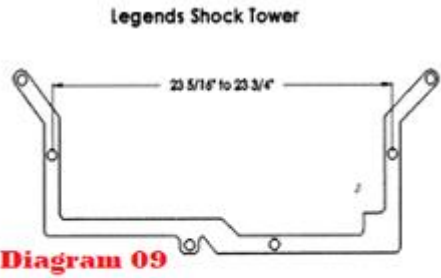
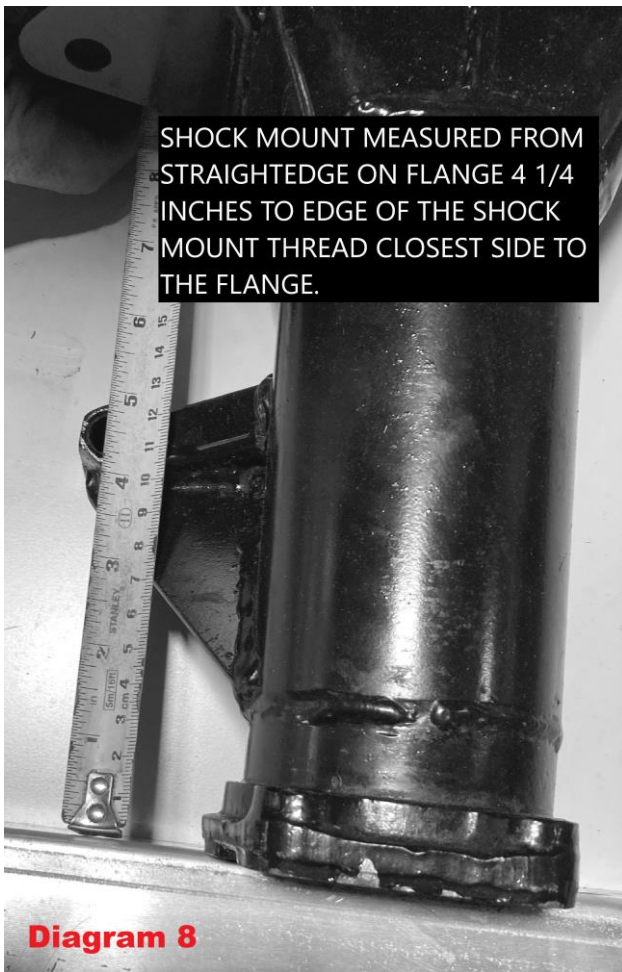

**REVISED RULES FOR 2025 HIGHLIGHTED IN BOLD/ITALIC RED PRINT
ITEMS MARKED STRIKETHROUGH ARE NO LONGER ALLOWED**

2025 Oval Track Legends Technical Specifications, Issue 3, Dated 17th April 2025